

TUBE FITTINGS

TABLE OF CONTENTS

Solutions for Life



04.~05. **MC Series**
GENLOK to male NPT thread



14. **U Series**
Unions



06.~07. **ME Series**
GENLOK to male NPT thread elbow



15. **UE Series**
Union Elbows

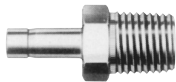

08. **MA Series**
Tube to male NPT thread

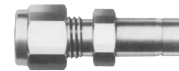

16.~17. **R Series**
Reducers

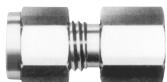

09.~10. **FC Series**
GENLOK to female NPT thread



18. **BU Series**
Bulkhead Unions

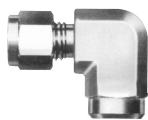

11.~12. **FE Series**
GENLOK to female NPT thread elbow

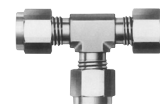

19. **UT Series**
Union Tees

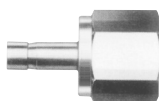

13. **FA Series**
Tube to female NPT thread



20. **UC Series**
Union Cross

TABLE OF CONTENTS

Solutions for Life

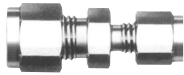

21. **RU Series**
Reducing Unions

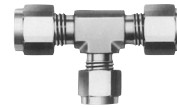

27. **RUT Series**
Reducing Union Tees

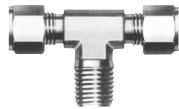

22.~23. **MBT Series**
GENLOK to male NPT thread Branch

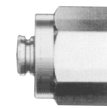

27. **P Series**
Plugs

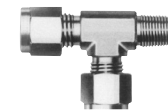

24. **MRT Series**
GENLOK to male NPT thread Run

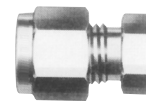

28. **C Series**
Caps



25. **FBT Series**
GENLOK to female NPT thread Branch

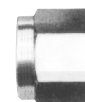

28. **N Series**
Nuts

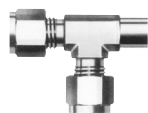

26. **FRT Series**
GENLOK to female NPT thread Run



29. **BF, FF, FSET Series**
Back Ferrules & Front Ferrules
& Ferrules Set



Company Overview

Genstar Technologies is a global leader in Gas Flow Control Systems for the industrial, specialty gas and medical sectors. We pride ourselves in our ability to provide our customers with high quality, value-added products and services that go beyond the industry standards. As a result, we have a global network of thousands of satisfied customers in over 60 countries.



Our Team

Our highly educated team of engineers, salespeople, technicians, managers, and customer service personnel are dedicated to providing you with products with the highest quality, reliability and performance. We hold the highest standards to our manufacturing processes; our total process management maximizes our production efficiency while ensuring product quality.

We work closely with all of our customers to design products specific to your needs. This includes developing new products, redesigning existing products, and customizing configuration / packaging. It is our priority to foster a strong relationship with each and every customer.

Quality Assurance

All of our products are manufactured under stringent quality control. We are ISO 9001:2001 and API certified.

Our products meet UL, CE, SEMI, and various international standards and certifications.

Manufacturing Capabilities

The manufacturing facility is equipped with CNC machines, electro-polishing equipment, and precision automated orbital welding systems, among other features, to ensure the production of the highest quality products.

Clean Room Facilities

Our class 10/100/1000 clean rooms are designed for Ultra High Purity (UHP) products. UHP products undergo precision machining, surface finishing, electro-polishing and passivation. All UHP products are cleaned by 18M Ω DI water in a cascade ultrasonic tank. To ensure the highest UHP product quality, they are then vacuum-dried and double-bagged.

Constitute

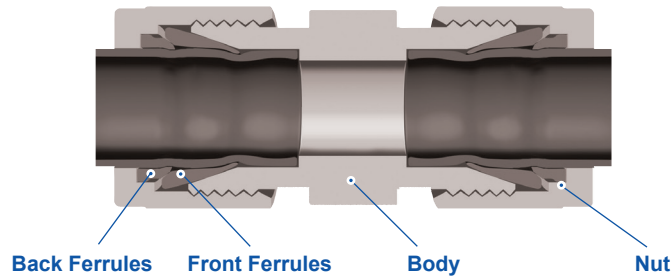

Ordering Informations

EXAMPLE : SS-MC-TF3M-NT4

Materials
SS-316

Series Number	
MC	Male Connector
MA	Male Adapter
ME	Male Elbow
MBT	Male Branch Tee
MRT	Male Run Tee
FC	Female Connector
FA	Female Adapter
FE	Female Elbow
FRT	Female Run Tee
FBT	Female Branch Tee
U	Union
RU	Reducing Union
RUT	Reducing Union Tee
BU	Bulkhead Union
UE	Union Elbow
UT	Union Tee
UC	Union Cross
N	Nut
C	Cap
P	Plug
R	Reducer
BF	Back Ferrule
FF	Front Ferrule
FSET	Ferrule Set

Inlet & Outlet Connections			
Types		Sizes	
T F	Tube Fitting	2	1/8"
		3	3/16"
		4	1/4"
N T	Male NPT	5	5/16"
		6	3/8"
		8	1/2"
FNT	Female NPT	10	5/8"
		12	3/4"
		14	7/8"
O D	Outer Diameter	16	1"
		3 M	3 mm
		6 M	6 mm
R T	Male ISO Tapered Thread (RT)	8 M	8 mm
		10 M	10 mm
		12 M	12 mm
FRT	Female ISO Tapered Thread (FRT)	16 M	16 mm
		18 M	18 mm
		22 M	22 mm
		25 M	25 mm

TUBE FITTINGS

Male Connectors

Solutions for Life

Male Connectors

GENLOK to Male NPT Thread

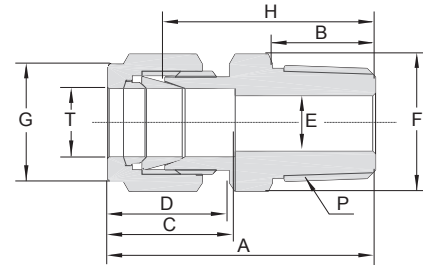

ENGLISH UNITS

Model Number	T Tube O.D. in.	P NPT Male Pipe Size in.	A in.	B in.	C in.	D in.	E in.	F Hex Flat in.	G Hex Flat in.	H in.
SS-MC-TF2-NT2	1/8	1/8	1.20	0.38	0.60	0.50	0.09	7/16	7/16	0.94
SS-MC-TF2-NT4	1/8	1/4	1.40	0.56	0.60	0.50	0.09	9/16	7/16	1.14
SS-MC-TF3-NT2	3/16*	1/8	1.23	0.38	0.63	0.54	0.12	7/16	1/2	0.97
SS-MC-TF3-NT4	3/16*	1/4	1.43	0.56	0.63	0.54	0.12	9/16	1/2	1.17
SS-MC-TF4-NT2	1/4	1/8	1.29	0.38	0.70	0.60	0.19	1/2	9/16	1.00
SS-MC-TF4-NT4	1/4	1/4	1.49	0.56	0.70	0.60	0.19	9/16	9/16	1.20
SS-MC-TF4-NT6	1/4	3/8	1.51	0.56	0.70	0.60	0.19	11/16	9/16	1.22
SS-MC-TF4-NT8	1/4	1/2	1.76	0.75	0.70	0.60	0.19	7/8	9/16	1.47
SS-MC-TF5-NT2	5/16*	1/8	1.34	0.38	0.73	0.64	0.19	9/16	5/8	1.05
SS-MC-TF5-NT4	5/16*	1/4	1.52	0.56	0.73	0.64	0.25	9/16	5/8	1.23
SS-MC-TF6-NT2	3/8	1/8	1.39	0.38	0.76	0.66	0.19	5/8	11/16	1.10
SS-MC-TF6-NT4	3/8	1/4	1.57	0.56	0.76	0.66	0.28	5/8	11/16	1.28
SS-MC-TF6-NT6	3/8	3/8	1.57	0.56	0.76	0.66	0.28	11/16	11/16	1.28
SS-MC-TF6-NT8	3/8	1/2	1.82	0.75	0.76	0.66	0.28	7/8	11/16	1.53
SS-MC-TF6-NT12	3/8	3/4	1.88	0.75	0.76	0.66	0.28	1-1/16	11/16	1.59
SS-MC-TF8-NT2	1/2	1/8	1.53	0.38	0.86	0.90	0.19	13/16	7/8	1.13
SS-MC-TF8-NT4	1/2	1/4	1.71	0.56	0.86	0.90	0.28	13/16	7/8	1.31
SS-MC-TF8-NT6	1/2	3/8	1.71	0.56	0.86	0.90	0.38	13/16	7/8	1.31
SS-MC-TF8-NT8	1/2	1/2	1.93	0.75	0.86	0.90	0.41	7/8	7/8	1.53
SS-MC-TF8-NT12	1/2	3/4	1.99	0.75	0.86	0.90	0.41	1-1/16	7/8	1.59
SS-MC-TF8-NT16	1/2	1	2.25	0.94	0.86	0.90	0.41	1-3/8	7/8	1.85
SS-MC-TF10-NT6	5/8*	3/8	1.74	0.56	0.86	0.96	0.38	15/16	1	1.34
SS-MC-TF10-NT8	5/8*	1/2	1.93	0.75	0.86	0.96	0.47	15/16	1	1.53
SS-MC-TF10-NT12	5/8*	3/4	1.99	0.75	0.86	0.96	0.50	1-1/16	1	1.59
SS-MC-TF12-NT8	3/4	1/2	1.99	0.75	0.86	0.96	0.47	1-1/16	1-1/8	1.59
SS-MC-TF12-NT12	3/4	3/4	1.99	0.75	0.86	0.96	0.62	1-1/16	1-1/8	1.59
SS-MC-TF12-NT16	3/4	1	2.25	0.94	0.86	0.96	0.62	1-3/8	1-1/8	1.85
SS-MC-TF16-NT12	1	3/4	2.26	0.75	1.04	1.23	0.62	1-3/8	1-1/2	1.78
SS-MC-TF16-NT16	1	1	2.45	0.94	1.04	1.23	0.88	1-3/8	1-1/2	1.97

Model Number	T Tube O.D. in.	P Tapered Pipe Thread (ISO PT)	A in.	B in.	C in.	D in.	E in.	F Hex Flat in.	G Hex Flat in.	H in.
SS-MC-TF2-RT2	1/8	1/8	1.20	0.38	0.60	0.50	0.09	7/16	7/16	0.94
SS-MC-TF2-RT4	1/8	1/4	1.40	0.56	0.60	0.50	0.09	9/16	7/16	1.14
SS-MC-TF4-RT2	1/4	1/8	1.29	0.38	0.70	0.60	0.19	1/2	9/16	1.00
SS-MC-TF4-RT4	1/4	1/4	1.49	0.56	0.70	0.60	0.19	9/16	9/16	1.20
SS-MC-TF4-RT6	1/4	3/8	1.51	0.56	0.70	0.60	0.19	11/16	9/16	1.22
SS-MC-TF6-RT4	3/8	1/4	1.57	0.56	0.76	0.66	0.28	5/8	11/16	1.28
SS-MC-TF6-RT6	3/8	3/8	1.57	0.56	0.76	0.66	0.28	11/16	11/16	1.28
SS-MC-TF8-RT8	1/2	1/2	1.93	0.75	0.86	0.90	0.41	7/8	7/8	1.53
SS-MC-TF12-RT12	3/4	3/4	1.99	0.75	0.86	0.96	0.62	1-1/16	1-1/8	1.59

*: Consult factory

METRIC UNITS

Model Number	T Tube O.D. mm	P NPT Male Pipe Size in.	A mm	B mm	C mm	D mm	E mm	F Hex Flat mm	G Hex Flat mm	H mm
SS-MC-TF3M-NT2	3	1/8	30.5	9.70	15.3	12.9	2.4	12	12	23.9
SS-MC-TF3M-NT4	3	1/4	35.6	14.2	15.3	12.9	2.4	14	12	29.0
SS-MC-TF6M-NT2	6	1/8	32.8	9.70	17.7	15.3	4.8	14	14	25.4
SS-MC-TF6M-NT4	6	1/4	37.9	14.2	17.7	15.3	4.8	14	14	30.5
SS-MC-TF6M-NT6	6	3/8	38.4	14.2	17.7	15.3	4.8	18	14	31.0
SS-MC-TF6M-NT8	6	1/2	44.7	19.0	17.7	15.3	4.8	22	14	37.3
SS-MC-TF8M-NT2	8	1/8	34.2	9.70	18.6	16.2	4.8	15	16	26.7
SS-MC-TF8M-NT4	8	1/4	38.7	14.2	18.6	16.2	6.4	15	16	31.2
SS-MC-TF8M-NT6	8	3/8	39.3	14.2	18.6	16.2	6.4	18	16	31.8
SS-MC-TF8M-NT8	8	1/2	45.6	19.0	18.6	16.2	6.4	22	16	38.1
SS-MC-TF10M-NT2	10	1/8	36.3	9.70	19.5	17.2	4.8	18	19	28.7
SS-MC-TF10M-NT4	10	1/4	40.9	14.2	19.5	17.2	7.9	18	19	33.3
SS-MC-TF10M-NT6	10	3/8	40.9	14.2	19.5	17.2	7.9	18	19	33.3
SS-MC-TF10M-NT8	10	1/2	46.5	19.0	19.5	17.2	7.9	22	19	38.9
SS-MC-TF10M-NT12	10	3/4	48.0	19.0	19.5	17.2	7.9	27	19	40.4
SS-MC-TF12M-NT2	12	1/8	38.8	9.70	22.0	22.8	4.8	22	22	28.7
SS-MC-TF12M-NT4	12	1/4	43.4	14.2	22.0	22.8	7.1	22	22	33.3
SS-MC-TF12M-NT6	12	3/8	43.4	14.2	22.0	22.8	9.5	22	22	33.3
SS-MC-TF12M-NT8	12	1/2	49.0	19.0	22.0	22.8	9.5	22	22	38.9
SS-MC-TF12M-NT12	12	3/4	50.5	19.0	22.0	22.8	9.5	27	22	40.4
SS-MC-TF14M-NT4	14	1/4	44.1	14.2	22.0	24.4	7.1	24	25	34.0
SS-MC-TF14M-NT6	14	3/8	44.1	14.2	22.0	24.4	9.5	24	25	34.0
SS-MC-TF14M-NT8	14	1/2	49.0	19.0	22.0	24.4	11.1	24	25	38.0
SS-MC-TF16M-NT6	16*	3/8	44.1	14.2	22.0	24.4	9.5	24	25	34.0
SS-MC-TF16M-NT8	16*	1/2	49.0	19.0	22.0	24.4	11.9	24	25	38.9
SS-MC-TF16M-NT12	16*	3/4	50.5	19.0	22.0	24.4	12.7	27	25	40.4
SS-MC-TF18M-NT8	18*	1/2	50.5	19.0	22.0	24.4	11.9	27	30	40.4
SS-MC-TF18M-NT12	18*	3/4	50.5	19.0	22.0	24.4	15.1	27	30	40.4
SS-MC-TF22M-NT12	22*	3/4	52.3	19.0	22.0	26.0	15.9	30	32	42.2
SS-MC-TF22M-NT16	22*	1	57.1	23.9	22.0	26.0	18.3	35	32	47.0
SS-MC-TF25M-NT8	25*	1/2	57.5	19.0	26.5	31.3	11.9	35	38	45.2
SS-MC-TF25M-NT12	25*	3/4	57.5	19.0	26.5	31.3	15.9	35	38	45.2
SS-MC-TF25M-NT16	25*	1	62.3	23.9	26.5	31.3	21.8	35	38	50.0

Model Number	T Tube O.D. mm	P Tapered Pipe Thread (ISO PT)	A mm	B mm	C mm	D mm	E mm	F Hex Flat mm	G Hex Flat mm	H mm
SS-MC-TF3M-RT2	3	1/8	30.5	9.70	15.3	12.9	2.4	12	12	23.9
SS-MC-TF3M-RT4	3	1/4	35.6	14.2	15.3	12.9	2.4	14	12	29.0
SS-MC-TF6M-RT2	6	1/8	32.8	9.70	17.7	15.3	4.8	14	14	25.4
SS-MC-TF6M-RT4	6	1/4	37.9	14.2	17.7	15.3	4.8	14	14	30.5
SS-MC-TF6M-RT6	6	3/8	38.4	14.2	17.7	15.3	4.8	18	14	31.0
SS-MC-TF8M-RT6	8	3/8	39.3	14.2	18.6	16.2	6.4	18	16	31.8
SS-MC-TF8M-RT8	8	1/2	45.6	19.0	18.6	16.2	6.4	22	16	38.1

*: Consult factory

TUBE FITTINGS

Male Elbows

Solutions for Life

Male Elbows

GENLOK to Male NPT Thread Elbow

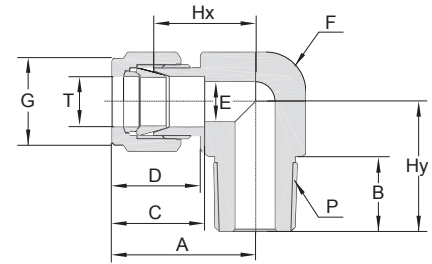
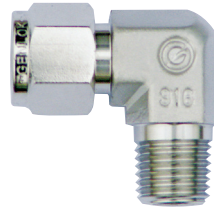

ENGLISH UNITS

Model Number	T Tube O.D. in.	P NPT Male Pipe Size in.	A in.	B in.	C in.	D in.	E in.	F Hex Flat in.	G Hex Flat in.	Hx in.	Hy in.
SS-ME-TF2-NT2	1/8	1/8	0.93	0.38	0.60	0.50	0.09	7/16	7/16	0.67	0.70
SS-ME-TF2-NT4	1/8	1/4	0.97	0.56	0.60	0.50	0.09	1/2	7/16	0.71	0.92
SS-ME-TF3-NT2	3/16*	1/8	1.00	0.38	0.63	0.54	0.12	1/2	1/2	0.74	0.74
SS-ME-TF3-NT4	3/16*	1/4	1.00	0.56	0.63	0.54	0.12	1/2	1/2	0.74	0.92
SS-ME-TF4-NT2	1/4	1/8	1.06	0.38	0.70	0.60	0.19	1/2	9/16	0.77	0.74
SS-ME-TF4-NT4	1/4	1/4	1.06	0.56	0.70	0.60	0.19	1/2	9/16	0.77	0.92
SS-ME-TF4-NT6	1/4	3/8	1.17	0.56	0.70	0.60	0.19	11/16	9/16	0.88	1.03
SS-ME-TF4-NT8	1/4	1/2	1.25	0.75	0.70	0.60	0.19	13/16	9/16	0.96	1.30
SS-ME-TF5-NT2	5/16*	1/8	1.13	0.38	0.73	0.64	0.19	9/16	5/8	0.84	0.78
SS-ME-TF5-NT4	5/16*	1/4	1.13	0.56	0.73	0.64	0.25	9/16	5/8	0.84	0.96
SS-ME-TF5-NT6	5/16*	3/8	1.20	0.56	0.73	0.64	0.25	11/16	5/8	0.91	1.03
SS-ME-TF6-NT2	3/8	1/8	1.20	0.38	0.76	0.66	0.19	5/8	11/16	0.91	0.82
SS-ME-TF6-NT4	3/8	1/4	1.20	0.56	0.76	0.66	0.28	5/8	11/16	0.91	1.00
SS-ME-TF6-NT6	3/8	3/8	1.23	0.56	0.76	0.66	0.28	11/16	11/16	0.94	1.03
SS-ME-TF6-NT8	3/8	1/2	1.31	0.75	0.76	0.66	0.28	13/16	11/16	1.02	1.30
SS-ME-TF6-NT12	3/8	3/4	1.46	0.75	0.76	0.66	0.28	1-1/16	11/16	1.17	1.45
SS-ME-TF8-NT4	1/2	1/4	1.42	0.56	0.86	0.90	0.28	13/16	7/8	1.02	1.11
SS-ME-TF8-NT6	1/2	3/8	1.42	0.56	0.86	0.90	0.38	13/16	7/8	1.02	1.11
SS-ME-TF8-NT8	1/2	1/2	1.42	0.75	0.86	0.90	0.41	13/16	7/8	1.02	1.30
SS-ME-TF8-NT12	1/2	3/4	1.57	0.75	0.86	0.90	0.41	1-1/16	7/8	1.17	1.45
SS-ME-TF10-NT6	5/8*	3/8	1.50	0.56	0.86	0.96	0.38	15/16	1	1.10	1.19
SS-ME-TF10-NT8	5/8*	1/2	1.50	0.75	0.86	0.96	0.47	15/16	1	1.10	1.38
SS-ME-TF10-NT12	5/8*	3/4	1.57	0.75	0.86	0.96	0.50	1-1/16	1	1.17	1.45
SS-ME-TF12-NT8	3/4	1/2	1.57	0.75	0.86	0.96	0.47	1-1/16	1-1/8	1.17	1.45
SS-ME-TF12-NT12	3/4	3/4	1.57	0.75	0.86	0.96	0.62	1-1/16	1-1/8	1.17	1.45
SS-ME-TF16-NT12	1	3/4	1.93	0.75	1.04	1.23	0.62	1-3/8	1-1/2	1.45	1.64
SS-ME-TF16-NT16	1	1	1.93	0.75	1.04	1.23	0.88	1-3/8	1-1/2	1.45	1.83

Model Number	T Tube O.D. in.	P Tapered Pipe Thread (ISO PT) in.	A in.	B in.	C in.	D in.	E in.	F Hex Flat in.	G Hex Flat in.	Hx in.	Hy in.
SS-ME-TF2-RT2	1/8	1/8	0.93	0.38	0.60	0.50	0.09	7/16	7/16	0.67	0.70
SS-ME-TF2-RT4	1/8	1/4	0.97	0.56	0.60	0.50	0.09	1/2	7/16	0.71	0.92
SS-ME-TF4-RT2	1/4	1/8	1.06	0.38	0.70	0.60	0.19	1/2	9/16	0.77	0.74
SS-ME-TF4-RT4	1/4	1/4	1.06	0.56	0.70	0.60	0.19	1/2	9/16	0.77	0.92
SS-ME-TF4-RT6	1/4	3/8	1.17	0.56	0.70	0.60	0.19	11/16	9/16	0.88	1.03
SS-ME-TF6-RT4	3/8	1/4	1.20	0.56	0.76	0.66	0.28	5/8	11/16	0.91	1.00
SS-ME-TF6-RT6	3/8	3/8	1.23	0.56	0.76	0.66	0.28	11/16	11/16	0.94	1.03
SS-ME-TF8-RT6	1/2	3/8	1.42	0.56	0.86	0.90	0.38	13/16	7/8	1.02	1.11
SS-ME-TF8-RT8	1/2	1/2	1.42	0.75	0.86	0.90	0.41	13/16	7/8	1.02	1.30
SS-ME-TF12-RT12	3/4	3/4	1.57	0.75	0.86	0.96	0.62	1-1/16	1-1/8	1.17	1.45

*: Consult factory

METRIC UNITS

Model Number	T Tube O.D. mm	P NPT Male Pipe Size in.	A mm	B mm	C mm	D mm	E mm	F Hex Flat mm	G Hex Flat mm	Hx mm	Hy mm
SS-ME-TF3M-NT2	3	1/8	23.6	9.70	15.3	12.9	2.4	11.1	12	17.0	17.8
SS-ME-TF3M-NT4	3	1/4	24.6	14.2	15.3	12.9	2.4	16.0	12	18.0	23.4
SS-ME-TF6M-NT2	6	1/8	27.0	9.70	17.7	15.3	4.8	12.7	14	19.6	18.8
SS-ME-TF6M-NT4	6	1/4	27.0	14.2	17.7	15.3	4.8	16.0	14	19.6	23.4
SS-ME-TF6M-NT6	6	3/8	29.8	14.2	17.7	15.3	4.8	20.5	14	22.4	26.2
SS-ME-TF6M-NT8	6	1/2	31.8	19.0	17.7	15.3	4.8	23.8	14	24.4	33.0
SS-ME-TF8M-NT2	8	1/8	28.8	9.70	18.6	16.2	4.8	16.0	16	21.3	19.8
SS-ME-TF8M-NT4	8	1/4	28.8	14.2	18.6	16.2	6.4	16.0	16	21.3	24.4
SS-ME-TF8M-NT6	8	3/8	30.6	14.2	18.6	16.2	6.4	20.5	16	23.1	26.2
SS-ME-TF8M-NT8	8	1/2	32.6	19.0	18.6	16.2	6.4	23.8	16	25.1	33.0
SS-ME-TF10M-NT2	10	1/8	31.5	9.70	19.5	17.2	4.8	16.0	19	23.9	21.6
SS-ME-TF10M-NT4	10	1/4	31.5	14.2	19.5	17.2	7.1	16.0	19	23.9	26.2
SS-ME-TF10M-NT6	10	3/8	31.5	14.2	19.5	17.2	7.9	20.5	19	23.9	26.2
SS-ME-TF10M-NT8	10	1/2	33.5	19.0	19.5	17.2	7.9	23.8	19	25.9	33.0
SS-ME-TF12M-NT4	12	1/4	36.0	14.2	22.0	22.8	7.1	20.5	22	25.9	28.2
SS-ME-TF12M-NT6	12	3/8	36.0	14.2	22.0	22.8	9.5	20.5	22	25.9	28.2
SS-ME-TF12M-NT8	12	1/2	36.0	19.0	22.0	22.8	9.5	23.8	22	25.9	33.0
SS-ME-TF12M-NT12	12	3/4	39.8	19.0	22.0	22.8	9.5	28.6	22	29.7	36.8
SS-ME-TF16M-NT6	16*	3/8	38.0	14.2	22.0	24.4	9.5	23.8	25	27.9	30.2
SS-ME-TF16M-NT8	16*	1/2	38.0	19.0	22.0	24.4	11.9	23.8	25	27.9	35.1
SS-ME-TF16M-NT12	16*	3/4	39.8	19.0	22.0	24.4	12.7	27	25	29.7	36.8
SS-ME-TF18M-NT8	18*	1/2	39.8	19.0	22.0	24.4	11.9	27	30	29.7	36.8
SS-ME-TF18M-NT12	18*	3/4	39.8	19.0	22.0	24.4	15.1	27	30	29.7	36.8
SS-ME-TF22M-NT12	22*	3/4	44.6	19.0	22.0	26.0	15.9	35	32	34.5	41.7
SS-ME-TF22M-NT16	22*	1	44.6	23.9	22.0	26.0	18.3	35	32	34.5	46.5
SS-ME-TF25M-NT12	25*	3/4	49.1	19.0	26.5	31.3	15.9	35	38	36.8	41.7
SS-ME-TF25M-NT16	25*	1	49.1	23.9	26.5	31.3	21.8	35	38	36.8	46.5

Model Number	T Tube O.D. mm	P Tapered Pipe Thread (ISO PT)	A mm	B mm	C mm	D mm	E mm	F Hex Flat mm	G Hex Flat mm	Hx mm	Hy mm
SS-ME-TF3M-RT2	3	1/8	23.6	9.70	15.3	12.9	2.4	11.1	12	17.0	17.8
SS-ME-TF6M-RT4	6	1/4	27.0	14.2	17.7	15.3	4.8	16.0	14	19.6	23.4
SS-ME-TF6M-RT6	6	3/8	29.8	14.2	17.7	15.3	4.8	20.5	14	22.4	26.2
SS-ME-TF8M-RT8	8	1/2	32.6	19.0	18.6	16.2	6.4	23.8	16	25.1	33.0

*: Consult factory

TUBE FITTINGS

Male Adapters

Solutions for Life

Male Adapters

Tube to Male NPT Thread

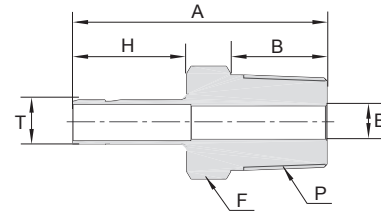
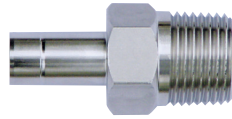

ENGLISH UNITS

Model Number	T Tube O.D. in.	P NPT Male Pipe Size in.	A in.	B in.	E in.	F Hex Flat in.	H in.
SS-MA-OD2-NT2	1/8	1/8	1.16	0.38	0.08	7/16	0.53
SS-MA-OD2-NT4	1/8	1/4	1.37	0.56	0.08	9/16	0.53
SS-MA-OD3-NT2	3/16*	1/8	1.19	0.38	0.12	7/16	0.56
SS-MA-OD3-NT4	3/16*	1/4	1.40	0.56	0.12	9/16	0.56
SS-MA-OD4-NT2	1/4	1/8	1.25	0.38	0.17	7/16	0.62
SS-MA-OD4-NT4	1/4	1/4	1.46	0.56	0.17	9/16	0.62
SS-MA-OD4-NT6	1/4	3/8	1.49	0.56	0.17	11/16	0.62
SS-MA-OD4-NT8	1/4	1/2	1.71	0.75	0.17	7/8	0.62
SS-MA-OD5-NT2	5/16*	1/8	1.29	0.38	0.19	7/16	0.65
SS-MA-OD5-NT4	5/16*	1/4	1.50	0.56	0.22	9/16	0.65
SS-MA-OD6-NT2	3/8	1/8	1.32	0.38	0.19	7/16	0.68
SS-MA-OD6-NT4	3/8	1/4	1.53	0.56	0.27	9/16	0.68
SS-MA-OD6-NT6	3/8	3/8	1.56	0.56	0.27	11/16	0.68
SS-MA-OD6-NT8	3/8	1/2	1.78	0.75	0.27	7/8	0.68
SS-MA-OD8-NT4	1/2	1/4	1.75	0.56	0.28	9/16	0.90
SS-MA-OD8-NT6	1/2	3/8	1.78	0.56	0.37	11/16	0.90
SS-MA-OD8-NT8	1/2	1/2	2.00	0.75	0.37	7/8	0.90
SS-MA-OD10-NT6	5/8*	3/8	1.81	0.56	0.47	11/16	0.96
SS-MA-OD10-NT8	5/8*	1/2	2.06	0.75	0.47	7/8	0.96
SS-MA-OD10-NT12	5/8*	3/4	2.03	0.75	0.50	1-1/16	0.96
SS-MA-OD12-NT8	3/4	1/2	2.06	0.75	0.47	7/8	0.96
SS-MA-OD12-NT12	3/4	3/4	2.06	0.75	0.58	1-1/16	0.96
SS-MA-OD12-NT16	3/4	1	2.28	0.94	0.58	1-3/8	0.96
SS-MA-OD16-NT12	1	3/4	2.31	0.75	0.62	1-1/16	1.21
SS-MA-OD16-NT16	1	1	2.60	0.94	0.80	1-3/8	1.21

METRIC UNITS

Model Number	T Tube O.D. mm	P NPT Male Pipe Size in.	A mm	B mm	E mm	F Hex Flat mm	H mm
SS-MA-OD6M-NT2	6	1/8	32.8	9.70	4.1	12	15.7
SS-MA-OD6M-NT4	6	1/4	38.1	14.2	4.1	14	15.7
SS-MA-OD8M-NT4	8	1/4	39.1	14.2	5.6	14	16.5
SS-MA-OD10M-NT4	10	1/4	39.9	14.2	7.1	14	17.3
SS-MA-OD10M-NT6	10	3/8	40.6	14.2	7.1	18	17.3
SS-MA-OD10M-NT8	10	1/2	46.2	19.1	7.1	22	17.3
SS-MA-OD12M-NT4	12	1/4	46.5	14.2	7.1	16	22.9
SS-MA-OD12M-NT8	12	1/2	52.1	19.1	8.8	22	22.9

*: Consult factory

Female Connectors

GENLOK to Female NPT Thread

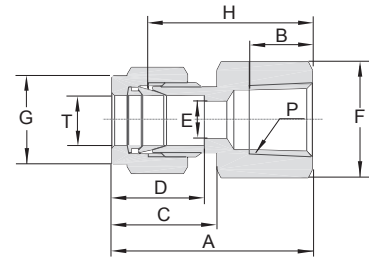
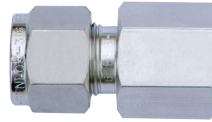

ENGLISH UNITS

Model Number	T Tube O.D. in.	P NPT Male Pipe Size in.	A in.	B in.	C in.	D in.	E in.	F Hex Flat in.	G Hex Flat in.	H in.
SS-FC-TF2-FNT2	1/8	1/8	1.13	0.41	0.60	0.50	0.09	9/16	7/16	0.87
SS-FC-TF2-FNT4	1/8	1/4	1.32	0.59	0.60	0.50	0.09	3/4	7/16	1.06
SS-FC-TF3-FNT2	3/16*	1/8	1.17	0.39	0.63	0.54	0.12	9/16	1/2	0.91
SS-FC-TF4-FNT2	1/4	1/8	1.23	0.39	0.70	0.60	0.19	9/16	9/16	0.94
SS-FC-TF4-FNT4	1/4	1/4	1.41	0.59	0.70	0.60	0.19	3/4	9/16	1.12
SS-FC-TF4-FNT6	1/4	3/8	1.48	0.59	0.70	0.60	0.19	7/8	9/16	1.19
SS-FC-TF4-FNT8	1/4	1/2	1.67	0.78	0.70	0.60	0.19	1-1/16	9/16	1.38
SS-FC-TF5-FNT2	5/16*	1/8	1.26	0.39	0.73	0.64	0.25	9/16	5/8	0.97
SS-FC-TF5-FNT4	5/16*	1/4	1.45	0.59	0.73	0.64	0.25	3/4	5/8	1.16
SS-FC-TF6-FNT2	3/8	1/8	1.29	0.39	0.76	0.66	0.28	5/8	11/16	1.00
SS-FC-TF6-FNT4	3/8	1/4	1.48	0.59	0.76	0.66	0.28	3/4	11/16	1.19
SS-FC-TF6-FNT6	3/8	3/8	1.54	0.59	0.76	0.66	0.28	7/8	11/16	1.25
SS-FC-TF6-FNT8	3/8	1/2	1.73	0.78	0.76	0.66	0.28	1-1/16	11/16	1.44
SS-FC-TF6-FNT12	3/8	3/4	1.88	0.81	0.76	0.66	0.28	1-5/16	11/16	1.59
SS-FC-TF8-FNT4	1/2	1/4	1.59	0.59	0.86	0.90	0.41	13/16	7/8	1.19
SS-FC-TF8-FNT6	1/2	3/8	1.65	0.59	0.86	0.90	0.41	7/8	7/8	1.25
SS-FC-TF8-FNT8	1/2	1/2	1.84	0.78	0.86	0.90	0.41	1-1/16	7/8	1.44
SS-FC-TF8-FNT12	1/2	3/4	1.90	0.81	0.86	0.90	0.41	1-5/16	7/8	1.50
SS-FC-TF10-FNT6	5/8*	3/8	1.65	0.59	0.86	0.96	0.50	15/16	1	1.25
SS-FC-TF10-FNT8	5/8*	1/2	1.84	0.78	0.86	0.96	0.50	1-1/16	1	1.44
SS-FC-TF12-FNT8	3/4	1/2	1.84	0.78	0.86	0.96	0.62	1-1/16	1-1/8	1.44
SS-FC-TF12-FNT12	3/4	3/4	1.90	0.81	0.86	0.96	0.62	1-5/16	1-1/8	1.50
SS-FC-TF16-FNT12	1	3/4	2.10	0.81	1.04	1.23	0.88	1-3/8	1-1/2	1.62
SS-FC-TF16-FNT16	1	1	2.45	1.00	1.04	1.23	0.88	1-5/8	1-1/2	1.97

Model Number	T Tube O.D. in.	P Tapered Pipe Thread (ISO PT)	A in.	B in.	C in.	D in.	E in.	F Hex Flat in.	G Hex Flat in.	H in.
SS-FC-TF2-FRT2	1/8	1/8	1.13	0.41	0.60	0.50	0.09	9/16	7/16	0.87
SS-FC-TF2-FRT4	1/8	1/4	1.32	0.59	0.60	0.50	0.09	3/4	7/16	1.06
SS-FC-TF4-FRT2	1/4	1/8	1.23	0.39	0.70	0.60	0.19	9/16	9/16	0.94
SS-FC-TF4-FRT4	1/4	1/4	1.41	0.59	0.70	0.60	0.19	3/4	9/16	1.12
SS-FC-TF4-FRT6	1/4	3/8	1.48	0.59	0.70	0.60	0.19	7/8	9/16	1.19
SS-FC-TF6-FRT4	3/8	1/4	1.48	0.59	0.76	0.66	0.28	3/4	11/16	1.19
SS-FC-TF6-FRT6	3/8	3/8	1.54	0.59	0.76	0.66	0.28	7/8	11/16	1.25
SS-FC-TF6-FRT8	3/8	1/2	1.73	0.78	0.76	0.66	0.28	1-1/16	11/16	1.44
SS-FC-TF8-FRT6	1/2	3/8	1.65	0.59	0.86	0.90	0.41	7/8	7/8	1.25
SS-FC-TF8-FRT8	1/2	1/2	1.84	0.78	0.86	0.90	0.41	1-1/16	7/8	1.44

*: Consult factory

TUBE FITTINGS

Female Connectors

Solutions for Life

Female Connectors

GENLOK to Female NPT Thread

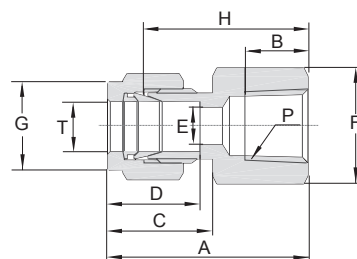
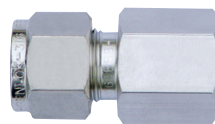

METRIC UNITS

Model Number	T Tube O.D. mm	P NPT Male Pipe Size in.	A mm	B mm	C mm	D mm	E mm	F Hex Flat mm	G Hex Flat mm	H mm
SS-FC-TF3M-FNT2	3	1/8	28.7	10.4	15.3	12.9	2.4	14	12	22.1
SS-FC-TF3M-FNT4	3	1/4	33.5	15.0	15.3	12.9	2.4	19	12	26.9
SS-FC-TF6M-FNT2	6	1/8	31.3	10.4	17.7	15.3	4.8	14	14	23.9
SS-FC-TF6M-FNT4	6	1/4	35.8	15.0	17.7	15.3	4.8	19	14	28.4
SS-FC-TF6M-FNT6	6	3/8	37.6	15.0	17.7	15.3	4.8	22	14	30.2
SS-FC-TF6M-FNT8	6	1/2	42.5	19.8	17.7	15.3	4.8	27	14	35.1
SS-FC-TF8M-FNT2	8	1/8	32.1	10.4	18.6	16.2	6.4	15	16	24.6
SS-FC-TF8M-FNT4	8	1/4	37.0	15.0	18.6	16.2	6.4	19	16	29.5
SS-FC-TF8M-FNT6	8	3/8	38.5	15.0	18.6	16.2	6.4	22	16	31.0
SS-FC-TF8M-FNT8	8	1/2	43.3	19.8	18.6	16.2	6.4	27	16	35.8
SS-FC-TF10M-FNT4	10	1/4	37.8	15.0	19.5	17.2	7.9	19	19	30.2
SS-FC-TF10M-FNT6	10	3/8	39.4	15.0	19.5	17.2	7.9	22	19	31.8
SS-FC-TF10M-FNT8	10	1/2	44.2	19.8	19.5	17.2	7.9	27	19	36.6
SS-FC-TF12M-FNT4	12	1/4	40.3	15.0	22.0	22.8	9.5	22	22	30.2
SS-FC-TF12M-FNT6	12	3/8	41.9	15.0	22.0	22.8	9.5	22	22	31.8
SS-FC-TF12M-FNT8	12	1/2	46.7	19.8	22.0	22.8	9.5	27	22	36.6

Model Number	T Tube O.D. mm	P Tapered Pipe Thread (ISO PT)	A mm	B mm	C mm	D mm	E mm	F Hex Flat mm	G Hex Flat mm	H mm
SS-FC-TF3M-FRT2	3	1/8	28.7	10.4	15.3	12.9	2.4	14	12	22.1
SS-FC-TF3M-FRT4	3	1/4	33.5	15.0	15.3	12.9	2.4	19	12	26.9
SS-FC-TF6M-FRT4	6	1/4	35.8	15.0	17.7	15.3	4.8	19	14	28.4
SS-FC-TF6M-FRT6	6	3/8	37.6	15.0	17.7	15.3	4.8	22	14	30.2
SS-FC-TF8M-FRT4	8	1/4	37.0	15.0	18.6	16.2	6.4	19	16	29.5
SS-FC-TF8M-FRT6	8	3/8	38.5	15.0	18.6	16.2	6.4	22	16	31.0
SS-FC-TF8M-FRT8	8	1/2	43.3	19.8	18.6	16.2	6.4	27	16	35.8

Female Elbows

GENLOK to Female NPT Thread Elbow

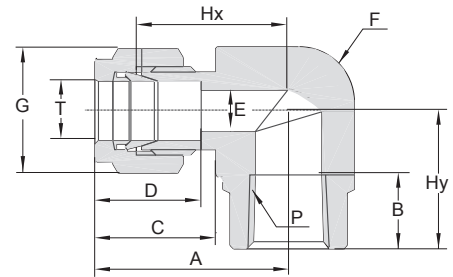
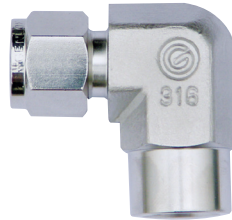

ENGLISH UNITS

Model Number	T Tube O.D. in.	P NPT Male Pipe Size in.	A in.	B in.	C in.	D in.	E in.	F Hex Flat in.	G Hex Flat in.	Hx in.	Hy in.
SS-FE-TF2-FNT2	1/8	1/8	0.97	0.41	0.60	0.50	0.09	1/2	7/16	0.71	0.75
SS-FE-TF2-FNT4	1/8	1/4	1.08	0.59	0.60	0.50	0.09	11/16	7/16	0.82	0.88
SS-FE-TF3-FNT2	3/16*	1/8	1.00	0.39	0.63	0.54	0.12	1/2	1/2	0.74	0.75
SS-FE-TF4-FNT2	1/4	1/8	1.06	0.39	0.70	0.60	0.19	1/2	9/16	0.77	0.75
SS-FE-TF4-FNT4	1/4	1/4	1.17	0.59	0.70	0.60	0.19	11/16	9/16	0.88	0.88
SS-FE-TF4-FNT6	1/4	3/8	1.25	0.59	0.70	0.60	0.19	13/16	9/16	0.96	0.88
SS-FE-TF4-FNT8	1/4	1/2	1.36	0.78	0.70	0.60	0.19	1	9/16	1.07	1.12
SS-FE-TF5-FNT2	5/16*	1/8	1.13	0.39	0.73	0.64	0.25	9/16	5/8	0.84	0.75
SS-FE-TF5-FNT4	5/16*	1/4	1.20	0.59	0.73	0.64	0.25	11/16	5/8	0.91	0.88
SS-FE-TF6-FNT2	3/8	1/8	1.20	0.39	0.76	0.66	0.28	5/8	11/16	0.91	0.75
SS-FE-TF6-FNT4	3/8	1/4	1.23	0.59	0.76	0.66	0.28	11/16	11/16	0.94	0.88
SS-FE-TF6-FNT6	3/8	3/8	1.31	0.59	0.76	0.66	0.28	13/16	11/16	1.02	0.88
SS-FE-TF6-FNT8	3/8	1/2	1.42	0.78	0.76	0.66	0.28	1	11/16	1.13	1.12
SS-FE-TF8-FNT4	1/2	1/4	1.42	0.59	0.86	0.90	0.41	13/16	7/8	1.02	0.88
SS-FE-TF8-FNT6	1/2	3/8	1.42	0.59	0.86	0.90	0.41	13/16	7/8	1.02	0.88
SS-FE-TF8-FNT8	1/2	1/2	1.53	0.78	0.86	0.90	0.41	1	7/8	1.13	1.12
SS-FE-TF10-FNT6	5/8*	3/8	1.50	0.59	0.86	0.96	0.50	15/16	1	1.10	0.88
SS-FE-TF10-FNT8	5/8*	1/2	1.57	0.78	0.86	0.96	0.50	1-1/16	1	1.17	1.12
SS-FE-TF12-FNT8	3/4	1/2	1.57	0.78	0.86	0.96	0.62	1-1/16	1-1/8	1.17	1.12
SS-FE-TF12-FNT12	3/4	3/4	1.76	0.81	0.86	0.96	0.62	1-3/8	1-1/8	1.36	1.25
SS-FE-TF16-FNT12	1	3/4	1.93	0.81	1.04	1.23	0.88	1-3/8	1-1/2	1.45	1.25
SS-FE-TF16-FNT16	1	1	2.11	1.00	1.04	1.23	0.88	1-11/16	1-1/2	1.50	1.50

Model Number	T Tube O.D. in.	P Tapered Pipe Thread (ISO PT)	A in.	B in.	C in.	D in.	E in.	F Hex Flat in.	G Hex Flat in.	Hx in.	Hy in.
SS-FE-TF2-FRT2	1/8	1/8	0.97	0.41	0.60	0.50	0.09	1/2	7/16	0.71	0.75
SS-FE-TF2-FRT4	1/8	1/4	1.08	0.59	0.60	0.50	0.09	11/16	7/16	0.82	0.88
SS-FE-TF4-FRT2	1/4	1/8	1.06	0.39	0.70	0.60	0.19	1/2	9/16	0.77	0.75
SS-FE-TF4-FRT4	1/4	1/4	1.17	0.59	0.70	0.60	0.19	11/16	9/16	0.88	0.88
SS-FE-TF4-FRT6	1/4	3/8	1.25	0.59	0.70	0.60	0.19	13/16	9/16	0.96	0.88
SS-FE-TF6-FRT4	3/8	1/4	1.23	0.59	0.76	0.66	0.28	11/16	11/16	0.94	0.88
SS-FE-TF6-FRT6	3/8	3/8	1.31	0.59	0.76	0.66	0.28	13/16	11/16	1.02	0.88
SS-FE-TF8-FRT6	1/2	3/8	1.42	0.59	0.86	0.90	0.41	13/16	7/8	1.02	0.88
SS-FE-TF8-FRT8	1/2	1/2	1.53	0.78	0.86	0.90	0.41	1	7/8	1.13	1.12

*: Consult factory

TUBE FITTINGS

Female Elbows

Solutions for Life

Female Elbows

GENLOK to Female NPT Thread Elbow

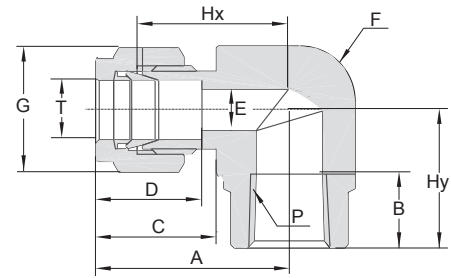

METRIC UNITS

Model Number	T Tube O.D. mm	P NPT Male Pipe Size in.	A mm	B mm	C mm	D mm	E mm	F Hex Flat mm	G Hex Flat mm	Hx mm	Hy mm
SS-FE-TF6M-FNT2	6	1/8	27.0	10.4	17.7	15.3	4.8	16.0	14	19.6	19.0
SS-FE-TF6M-FNT4	6	1/4	29.8	15.0	17.7	15.3	4.8	20.5	14	22.4	22.4
SS-FE-TF6M-FNT8	6	1/2	34.6	19.8	17.7	15.3	4.8	28.5	14	27.2	28.4
SS-FE-TF8M-FNT4	8	1/4	30.6	15.0	18.6	16.2	6.4	20.5	16	23.1	22.4
SS-FE-TF10M-FNT2	10	1/8	31.5	10.4	19.5	17.2	7.9	20.5	19	23.9	19.0
SS-FE-TF10M-FNT4	10	1/4	33.5	15.0	19.5	17.2	7.9	20.5	19	25.9	22.4
SS-FE-TF12M-FNT4	12	1/4	36.0	15.0	22.0	22.8	9.5	20.5	22	25.9	22.4
SS-FE-TF12M-FNT8	12	1/2	38.8	19.8	22.0	22.8	9.5	28.5	22	28.7	28.4

Model Number	T Tube O.D. mm	P Tapered Pipe Thread (ISO PT)	A mm	B mm	C mm	D mm	E mm	F Hex Flat mm	G Hex Flat mm	Hx mm	Hy mm
SS-FE-TF6M-FRT4	6	1/4	29.8	15.0	17.7	15.3	4.8	20.5	14	22.4	22.4
SS-FE-TF8M-FRT4	8	1/4	30.6	15.0	18.6	16.2	6.4	20.5	16	23.1	22.4
SS-FE-TF10M-FRT4	10	1/4	33.5	15.0	19.5	17.2	7.9	20.5	19	25.9	22.4
SS-FE-TF12M-FRT8	12	1/2	38.8	19.8	22.0	22.8	9.5	28.5	22	28.7	28.4

Female Adapters

Tube to Female NPT Thread

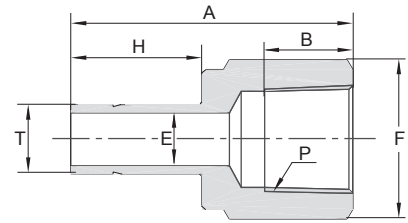
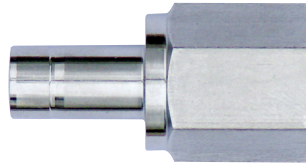

ENGLISH UNITS

Model Number	T Tube O.D. in.	P NPT Male Pipe Size in.	A in.	B in.	E in.	F Hex Flat in.	H in.
SS-FA-OD2-FNT2	1/8	1/8	1.24	0.41	0.08	9/16	0.53
SS-FA-OD2-FNT4	1/8	1/4	0.39	0.59	0.08	3/4	0.53
SS-FA-OD3-FNT2	3/16*	1/8	1.26	0.41	0.12	9/16	0.56
SS-FA-OD3-FNT4	3/16*	1/4	1.41	0.59	0.12	3/4	0.56
SS-FA-OD4-FNT2	1/4	1/8	1.30	0.41	0.17	9/16	0.62
SS-FA-OD4-FNT4	1/4	1/4	1.46	0.59	0.17	3/4	0.62
SS-FA-OD4-FNT6	1/4	3/8	1.55	0.59	0.17	7/8	0.62
SS-FA-OD4-FNT8	1/4	1/2	1.79	0.78	0.17	1-1/16	0.62
SS-FA-OD5-FNT2	5/16*	1/8	1.35	0.41	0.22	9/16	0.65
SS-FA-OD5-FNT4	5/16*	1/4	1.48	0.59	0.22	3/4	0.65
SS-FA-OD6-FNT2	3/8	1/8	1.35	0.41	0.27	9/16	0.68
SS-FA-OD6-FNT4	3/8	1/4	1.50	0.59	0.27	3/4	0.68
SS-FA-OD6-FNT6	3/8	3/8	1.59	0.59	0.27	7/8	0.68
SS-FA-OD6-FNT8	3/8	1/2	1.84	0.78	0.27	1-1/16	0.68
SS-FA-OD8-FNT4	1/2	1/4	1.71	0.59	0.37	3/4	0.90
SS-FA-OD8-FNT6	1/2	3/8	1.79	0.59	0.37	7/8	0.90
SS-FA-OD8-FNT8	1/2	1/2	2.05	0.78	0.37	1-1/16	0.90
SS-FA-OD10-FNT6	5/8*	3/8	1.90	0.59	0.47	7/8	0.96
SS-FA-OD10-FNT8	5/8*	1/2	2.09	0.78	0.47	1-1/16	0.96
SS-FA-OD10-FNT12	5/8*	3/4	2.18	0.81	0.47	1-1/4	0.96
SS-FA-OD12-FNT8	3/4	1/2	2.08	0.78	0.58	1-1/16	0.96
SS-FA-OD12-FNT12	3/4	3/4	2.16	0.81	0.58	1-5/16	0.96
SS-FA-OD12-FNT16	3/4	1	2.30	1.00	0.58	1-5/8	0.96
SS-FA-OD16-FNT12	1	3/4	2.39	0.81	0.80	1-5/16	1.21
SS-FA-OD16-FNT16	1	1	2.53	1.00	0.80	1-5/8	1.21

METRIC UNITS

Model Number	T Tube O.D. in.	P NPT Male Pipe Size in.	A mm	B mm	E mm	F Hex Flat mm	H mm
SS-FA-OD6M-FNT2	6	1/8	32.5	10.4	4.6	14	15.7
SS-FA-OD6M-FNT4	6	1/4	37.1	15.0	4.6	19	15.7
SS-FA-OD8M-FNT4	8	1/4	37.6	15.0	6.4	19	16.5
SS-FA-OD10M-FNT4	10	1/4	38.1	15.0	7.7	19	17.3
SS-FA-OD10M-FNT6	10	3/8	40.1	15.0	7.7	22	17.3
SS-FA-OD10M-FNT8	10	1/2	46.5	19.8	7.7	27	17.3
SS-FA-OD12M-FNT4	12	1/4	43.7	15.0	9.1	19	22.8
SS-FA-OD12M-FNT8	12	1/2	52.3	19.8	9.1	27	22.8

*: Consult factory

TUBE FITTINGS

Unions

Solutions for Life

Unions

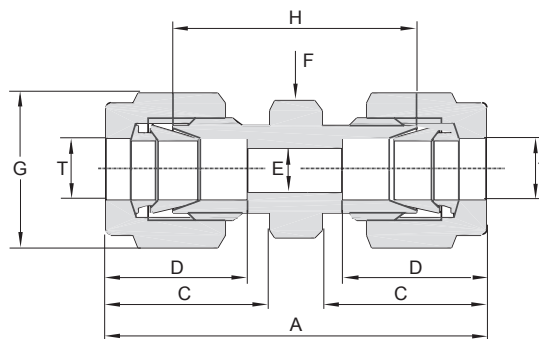
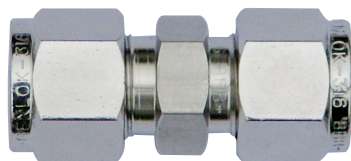

ENGLISH UNITS

Model Number	T Tube O.D. in.	A in.	C in.	D in.	E in.	F Hex Flat in.	G Hex Flat in.	H in.
SS-U-TF2	1/8	1.40	0.60	0.50	0.09	7/16	7/16	0.88
SS-U-TF3	3/16*	1.47	0.63	0.54	0.12	7/16	1/2	0.95
SS-U-TF4	1/4	1.61	0.70	0.60	0.19	1/2	9/16	1.03
SS-U-TF5	5/16*	1.69	0.73	0.64	0.25	9/16	5/8	1.11
SS-U-TF6	3/8	1.77	0.76	0.66	0.28	5/8	11/16	1.19
SS-U-TF8	1/2	2.02	0.86	0.90	0.41	13/16	7/8	1.22
SS-U-TF10	5/8*	2.05	0.86	0.96	0.50	15/16	1	1.25
SS-U-TF12	3/4	2.11	0.86	0.96	0.62	1-1/16	1-1/8	1.31
SS-U-TF16	1	2.55	1.04	1.23	0.88	1-3/8	1-1/2	1.59

METRIC UNITS

Model Number	T Tube O.D. mm	A mm	C mm	D mm	E mm	F Hex Flat mm	G Hex Flat mm	H mm
SS-U-TF3M	3	35.3	15.3	12.9	2.4	12	12	22.1
SS-U-TF6M	6	41.0	17.7	15.3	4.8	14	14	26.2
SS-U-TF8M	8	43.2	18.6	16.2	6.4	15	16	28.2
SS-U-TF10M	10	46.2	19.5	17.2	7.9	18	19	31.0
SS-U-TF12M	12	51.2	22.0	22.8	9.5	22	22	31.0
SS-U-TF14M	14	52.0	22.0	24.4	11.1	24	25	31.8
SS-U-TF16M	16*	52.0	22.0	24.4	12.7	24	25	31.8
SS-U-TF18M	18*	53.5	22.0	24.4	15.1	27	30	33.3
SS-U-TF22M	22*	55.0	22.0	26.0	18.3	30	32	34.8
SS-U-TF25M	25*	65.0	26.5	31.3	21.8	35	38	40.4

*: Consult factory

Union Elbows

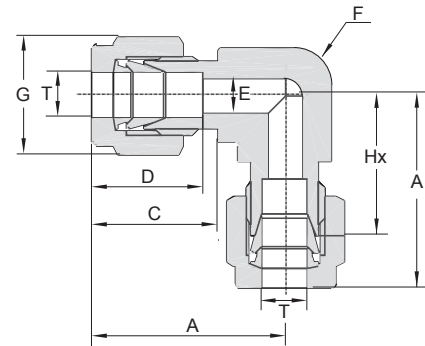

ENGLISH UNITS

Model Number	T Tube O.D. in.	A in.	C in.	D in.	E in.	F Hex Flat in.	G Hex Flat in.	H in.
SS-UE-TF2	1/8	0.88	0.60	0.50	0.09	3/8	7/16	0.62
SS-UE-TF3	3/16*	1.00	0.63	0.54	0.12	1/2	1/2	0.74
SS-UE-TF4	1/4	1.06	0.70	0.60	0.19	1/2	9/16	0.77
SS-UE-TF5	5/16*	1.13	0.73	0.64	0.25	9/16	5/8	0.84
SS-UE-TF6	3/8	1.20	0.76	0.66	0.28	5/8	11/16	0.91
SS-UE-TF8	1/2	1.42	0.86	0.90	0.41	13/16	7/8	1.02
SS-UE-TF10	5/8*	1.50	0.86	0.96	0.50	15/16	1	1.10
SS-UE-TF12	3/4	1.57	0.86	0.96	0.62	1-1/16	1-1/8	1.17
SS-UE-TF16	1	1.93	1.04	1.23	0.88	1-3/8	1-1/2	1.45

METRIC UNITS

Model Number	T Tube O.D. mm	A mm	C mm	D mm	E mm	F Hex Flat mm	G Hex Flat mm	H mm
SS-UE-TF3M	3	22.3	15.3	12.9	2.4	9.50	12	15.7
SS-UE-TF6M	6	27.0	17.7	15.3	4.8	12.7	14	19.6
SS-UE-TF8M	8	28.8	18.8	16.2	6.4	16.0	16	21.3
SS-UE-TF10M	10	31.5	19.5	17.2	7.9	20.5	19	23.9
SS-UE-TF12M	12	36.0	22.0	22.8	9.5	20.5	22	25.9
SS-UE-TF14M	14	38.0	22.0	24.4	11.1	23.8	25	27.9
SS-UE-TF16M	16*	38.0	22.0	24.4	12.7	23.8	25	27.9
SS-UE-TF18M	18*	39.8	22.0	24.4	15.1	27	30	29.7
SS-UE-TF22M	22*	44.6	22.0	26.0	18.3	35	32	34.5
SS-UE-TF25M	25*	49.1	26.5	31.3	21.8	35	38	36.8

*: Consult factory

TUBE FITTINGS

Reducers

Solutions for Life

Reducers

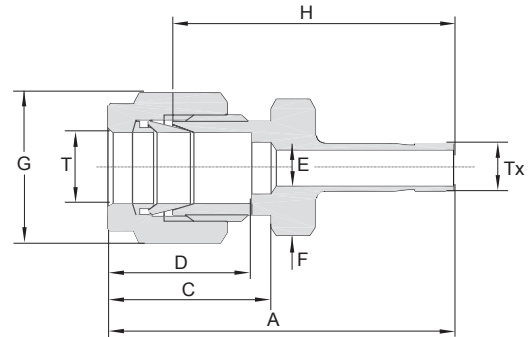
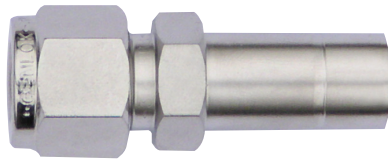

ENGLISH UNITS

Model Number	T Tube O.D. in.	Tx Tube O.D. in.	A in.	C in.	D in.	E in.	F Hex Flat in.	G Hex Flat in.	H in.
SS-R-TF2-OD3	1/8	3/16	1.35	0.60	0.50	0.09	7/16	7/16	1.09
SS-R-TF2-OD4	1/8	1/4	1.42	0.60	0.50	0.09	7/16	7/16	1.16
SS-R-TF2-OD6	1/8	3/8	1.48	0.60	0.50	0.09	7/16	7/16	1.22
SS-R-TF2-OD8	1/8	1/2	1.74	0.60	0.50	0.09	9/16	7/16	1.48
SS-R-TF3-OD2	3/16*	1/8	1.37	0.63	0.54	0.08	7/16	1/2	1.11
SS-R-TF3-OD4	3/16*	1/4	1.46	0.63	0.54	0.12	7/16	1/2	1.20
SS-R-TF4-OD2	1/4	1/8	1.45	0.70	0.60	0.08	1/2	9/16	1.16
SS-R-TF4-OD3	1/4	3/16	1.48	0.70	0.60	0.12	1/2	9/16	1.19
SS-R-TF4-OD5	1/4	5/16	1.57	0.70	0.60	0.19	1/2	9/16	1.28
SS-R-TF4-OD6	1/4	3/8	1.60	0.70	0.60	0.19	1/2	9/16	1.31
SS-R-TF4-OD8	1/4	1/2	1.82	0.70	0.60	0.19	9/16	9/16	1.53
SS-R-TF4-OD10	1/4	5/8	1.89	0.70	0.60	0.19	11/16	9/16	1.60
SS-R-TF4-OD12	1/4	3/4	1.88	0.70	0.60	0.19	13/16	9/16	1.59
SS-R-TF5-OD6	5/16*	3/8	1.65	0.73	0.64	0.25	9/16	5/8	1.36
SS-R-TF5-OD8	5/16*	1/4	1.87	0.73	0.64	0.25	9/16	5/8	1.58
SS-R-TF6-OD4	3/8	1/4	0.63	0.76	0.66	0.17	5/8	11/16	1.34
SS-R-TF6-OD8	3/8	1/2	1.91	0.76	0.66	0.28	5/8	11/16	1.62
SS-R-TF6-OD10	3/8	5/8	1.98	0.76	0.66	0.28	11/16	11/16	1.69
SS-R-TF6-OD12	3/8	3/4	1.98	0.76	0.66	0.28	13/16	11/16	1.69
SS-R-TF8-OD4	1/2	1/4	1.77	0.86	0.90	0.17	13/16	7/8	1.37
SS-R-TF8-OD6	1/2	3/8	1.84	0.86	0.90	0.27	13/16	7/8	1.44
SS-R-TF8-OD10	1/2	5/8	2.12	0.86	0.90	0.41	13/16	7/8	1.72
SS-R-TF8-OD12	1/2	3/4	2.12	0.86	0.90	0.41	13/16	7/8	1.72
SS-R-TF8-OD16	1/2	1	2.37	0.86	0.90	0.41	1-1/16	7/8	1.97
SS-R-TF10-OD12	5/8*	3/4	2.15	0.86	0.96	0.50	15/16	1	1.75
SS-R-TF10-OD14	5/8*	7/8	2.21	0.86	0.96	0.50	15/16	1	1.81
SS-R-TF10-OD16	5/8*	1	2.40	0.86	0.96	0.50	1-1/16	1	2.00
SS-R-TF12-OD8	3/4	1/2	2.15	0.86	0.96	0.37	1-1/16	1-1/8	1.75
SS-R-TF12-OD16	3/4	1	2.46	0.86	0.96	0.62	1-1/16	1-1/8	2.06
SS-R-TF16-OD20	1	1-1/4	3.17	1.04	1.23	0.88	1-3/8	1-1/2	2.69
SS-R-TF16-OD24	1	1-1/2	3.51	1.04	1.23	0.88	1-5/8	1-1/2	3.03
SS-R-TF16-OD32	1	2	4.43	1.04	1.23	0.88	2-1/8	1-1/2	3.95

*: Consult factory

Reducers

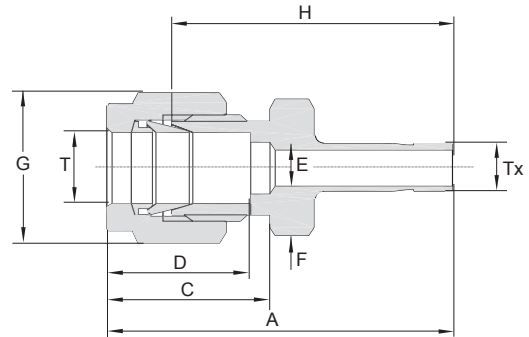
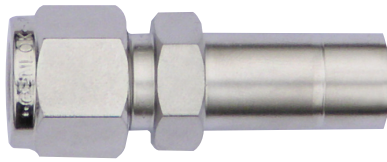

METRIC UNITS

Model Number	T Tube O.D. mm	Tx Tube O.D. mm	A mm	C mm	D mm	E mm	F Hex Flat mm	G Hex Flat mm	H mm
SS-R-TF3M-OD6M	3	6	36.1	15.3	12.9	2.4	12	12	29.5
SS-R-TF3M-OD10M	3	10	38.4	15.3	12.9	2.4	14	12	31.8
SS-R-TF6M-OD3M	6	3	36.9	17.7	15.3	1.8	14	14	29.5
SS-R-TF6M-OD8M	6	8	39.9	17.7	15.3	4.8	14	14	32.5
SS-R-TF6M-OD10M	6	10	40.7	17.7	15.3	4.8	14	14	33.3
SS-R-TF6M-OD12M	6	12	46.3	17.7	15.3	4.8	14	14	38.9
SS-R-TF8M-OD6M	8	6	40.3	18.6	16.2	4.6	15	16	32.8
SS-R-TF8M-OD10M	8	10	42.0	18.6	16.2	6.4	15	16	34.5
SS-R-TF8M-OD12M	8	12	47.6	18.6	16.2	6.4	15	16	40.1
SS-R-TF10M-OD6M	10	6	42.4	19.5	17.2	4.6	18	19	34.8
SS-R-TF10M-OD8M	10	8	43.4	19.5	17.2	6.4	18	19	35.8
SS-R-TF10M-OD12M	10	12	49.8	19.5	17.2	7.9	18	19	42.2
SS-R-TF12M-OD6M	12	6	44.9	22.0	22.8	4.6	22	22	34.8
SS-R-TF12M-OD8M	12	8	45.9	22.0	22.8	6.4	22	22	35.8
SS-R-TF12M-OD10M	12	10	46.7	22.0	22.8	7.7	22	22	36.6

TUBE FITTINGS

Bulkhead Unions

Solutions for Life

Bulkhead Unions

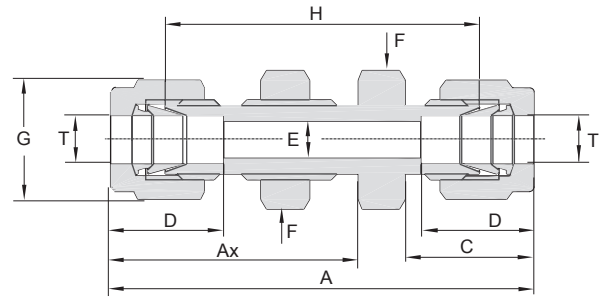
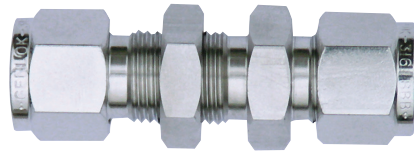

ENGLISH UNITS

Model Number	T Tube O.D. in.	A in.	Ax in.	C in.	D in.	E in.	F Hex Flat in.	G Hex Flat in.	H in.	Hx in.	Panel Hole Drill Size in.	Max Panel Thickness in.
SS-BU-TF2	1/8	2.02	1.23	0.60	0.50	0.09	1/2	7/16	1.50	0.97	0.33	0.50
SS-BU-TF3	3/16*	2.11	1.26	0.63	0.54	0.12	9/16	1/2	1.59	1.00	0.39	0.50
SS-BU-TF4	1/4	2.27	1.32	0.70	0.60	0.19	5/8	9/16	1.69	1.03	0.45	0.40
SS-BU-TF5	5/16*	2.39	1.41	0.73	0.64	0.25	11/16	5/8	1.81	1.12	0.52	0.44
SS-BU-TF6	3/8	2.45	1.45	0.76	0.66	0.28	3/4	11/16	1.87	1.16	0.58	0.44
SS-BU-TF8	1/2	2.80	1.65	0.86	0.90	0.41	15/16	7/8	2.00	1.25	0.76	0.50
SS-BU-TF10	5/8*	2.86	1.68	0.86	0.96	0.50	1-1/16	1	2.06	1.28	0.89	0.50
SS-BU-TF12	3/4	3.11	1.87	0.86	0.96	0.62	1-3/16	1-1/8	2.31	1.47	1.02	0.66
SS-BU-TF16	1	3.77	2.26	1.04	1.23	0.88	1-5/8	1-1/2	2.81	1.78	1.33	0.75

METRIC UNITS

Model Number	T Tube O.D. mm	A mm	Ax mm	C mm	D mm	E mm	F Hex Flat mm	G Hex Flat mm	H mm	Hx mm	Panel Hole Drill Size mm	Max Panel Thickness mm
SS-BU-TF3M	3	51.3	31.2	15.3	12.9	2.4	14	12	38.1	24.6	8.30	12.7
SS-BU-TF6M	6	57.7	33.6	17.7	15.3	4.8	16	14	42.9	26.2	11.5	10.2
SS-BU-TF8M	8	61.0	36.1	18.6	16.2	6.4	18	16	46.0	28.6	13.1	11.2
SS-BU-TF10M	10	63.7	37.0	19.5	17.2	7.9	22	19	48.5	29.4	16.3	11.2
SS-BU-TF12M	12	71.0	41.9	22.0	22.8	9.5	24	22	50.8	31.8	19.5	12.7

*: Consult factory

Union Tees

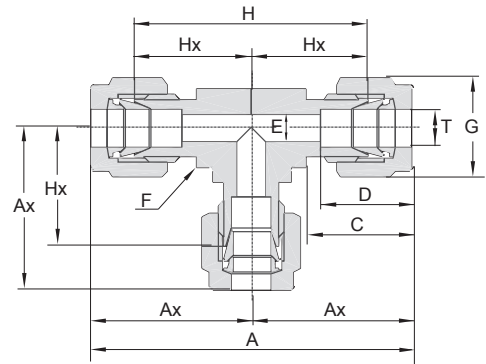
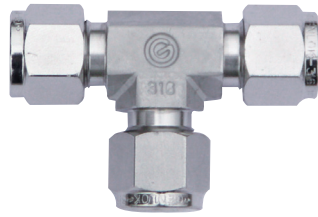

ENGLISH UNITS

Model Number	T Tube O.D. in.	A in.	Ax in.	C in.	D in.	E in.	F Hex Flat in.	G Hex Flat in.	H in.	Hx in.
SS-UT-TF2	1/8	1.76	0.88	0.60	0.50	0.09	3/8	7/16	1.24	0.62
SS-UT-TF3	3/16*	1.92	0.96	0.63	0.54	0.12	7/16	1/2	1.40	0.70
SS-UT-TF4	1/4	2.12	1.06	0.70	0.60	0.19	1/2	9/16	1.54	0.77
SS-UT-TF5	5/16*	2.34	1.17	0.73	0.64	0.25	5/8	5/8	1.76	0.88
SS-UT-TF6	3/8	2.40	1.20	0.76	0.66	0.28	5/8	11/16	1.82	0.91
SS-UT-TF8	1/2	2.84	1.42	0.86	0.90	0.41	13/16	7/8	2.04	1.02
SS-UT-TF10	5/8*	3.06	1.53	0.86	0.96	0.50	1	1	2.26	1.13
SS-UT-TF12	3/4	3.14	1.57	0.86	0.96	0.62	1-1/16	1-1/8	2.34	1.17
SS-UT-TF16	1	3.86	1.93	1.04	1.23	0.88	1-3/8	1-1/2	2.90	1.45

METRIC UNITS

Model Number	T Tube O.D. mm	A mm	Ax mm	C mm	D mm	E mm	F Hex Flat mm	G Hex Flat mm	H mm	Hx mm
SS-UT-TF3M	3	44.7	22.3	15.3	12.9	2.4	9.50	12	31.5	15.7
SS-UT-TF6M	6	53.9	27.0	17.7	15.3	4.8	12.7	14	39.1	19.6
SS-UT-TF8M	8	59.7	29.9	18.6	16.2	6.4	16.0	16	44.7	22.4
SS-UT-TF10M	10	63.0	31.5	19.5	17.2	7.9	20.5	19	47.8	23.9
SS-UT-TF12M	12	72.0	36.0	22.0	22.8	9.5	20.5	22	51.8	25.9
SS-UT-TF14M	14	77.6	38.8	22.0	24.4	11.1	25.4	25	57.4	28.7
SS-UT-TF16M	16*	77.6	38.8	22.0	24.4	12.7	25.4	25	57.4	28.7
SS-UT-TF18M	18*	79.5	38.8	22.0	24.4	15.1	27	30	59.4	29.7
SS-UT-TF22M	22*	89.3	44.6	22.0	26.0	18.3	35	32	69.1	34.5
SS-UT-TF25M	25*	98.3	49.1	26.5	31.3	21.8	35	38	73.7	36.8

*: Consult factory

TUBE FITTINGS

Union Cross

Solutions for Life

UC Union Cross

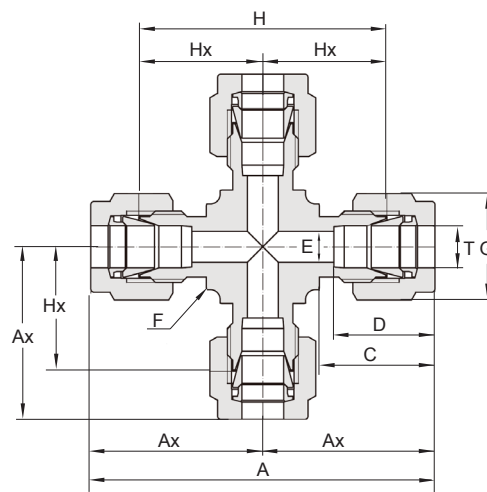

ENGLISH UNITS

Model Number	T Tube O.D. in.	A in.	Ax in.	C in.	D in.	E in.	F Hex Flat in.	G Hex Flat in.	H in.	Hx in.
SS-UC-TF2	1/8	1.90	0.95	0.60	0.50	0.09	1/2	7/16	1.38	0.69
SS-UC-TF4	1/4	2.08	1.04	0.69	0.60	0.19	1/2	9/16	1.50	0.75
SS-UC-TF6	3/8	2.48	1.24	0.76	0.66	0.28	5/8	11/16	1.89	0.94
SS-UC-TF8	1/2	2.93	1.46	0.87	0.90	0.41	13/16	7/8	2.13	1.06

METRIC UNITS

Model Number	T Tube O.D. mm	A mm	Ax mm	C mm	D mm	E mm	F Hex Flat mm	G Hex Flat mm	H mm	Hx mm
SS-UC-TF3M	3	48.20	24.10	15.30	12.90	2.40	12.70	12.00	35.00	17.50
SS-UC-TF6M	6	53.90	27.00	17.70	15.30	4.80	12.70	14.00	39.10	19.60
SS-UC-TF8M	8	59.70	29.90	18.60	16.20	6.40	16.00	16.00	44.70	22.40
SS-UC-TF10M	10	63.00	31.50	19.50	17.20	7.90	20.50	19.00	47.80	23.90
SS-UC-TF12M	12	72.00	36.00	22.00	22.80	9.50	20.50	22.00	51.80	25.90

*: Consult factory

Reducing Unions

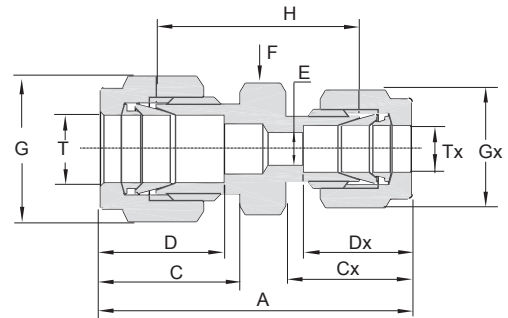
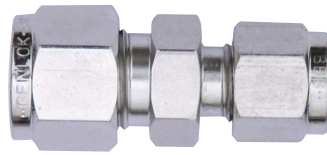

ENGLISH UNITS

Model Number	T Tube O.D. in.	Tx Tube O.D. in.	A in.	C in.	Cx in.	D in.	Dx in.	E in.	F Hex Flat in.	G Hex Flat in.	Gx in.	H in.
SS-RU-TF3-TF2	3/16*	1/8	1.44	0.63	0.60	0.54	0.50	0.09	7/16	1/2	7/16	0.92
SS-RU-TF4-TF2	1/4	1/8	1.52	0.70	0.60	0.60	0.50	0.09	1/2	9/16	7/16	0.97
SS-RU-TF4-TF3	1/4	3/16	1.55	0.70	0.63	0.60	0.54	0.12	1/2	9/16	1/2	1.00
SS-RU-TF5-TF2	5/16*	1/8	1.56	0.73	0.60	0.64	0.50	0.09	9/16	5/8	7/16	1.02
SS-RU-TF5-TF4	5/16*	1/4	1.66	0.73	0.70	0.64	0.60	0.19	9/16	5/8	9/16	1.08
SS-RU-TF6-TF2	3/8	1/8	0.76	0.76	0.60	0.66	0.50	0.09	5/8	11/16	7/16	1.06
SS-RU-TF6-TF4	3/8	1/4	1.61	0.76	0.70	0.66	0.60	0.19	5/8	11/16	9/16	1.12
SS-RU-TF6-TF5	3/8	5/16	1.74	0.76	0.73	0.66	0.64	0.25	5/8	11/16	5/8	1.16
SS-RU-TF8-TF2	1/2	1/8	1.78	0.86	0.60	0.90	0.50	0.09	13/16	7/8	7/16	1.12
SS-RU-TF8-TF4	1/2	1/4	1.85	0.86	0.70	0.90	0.19	0.19	13/16	7/8	9/16	1.16
SS-RU-TF8-TF6	1/2	3/8	1.91	0.86	0.76	0.90	0.66	0.28	13/16	7/8	11/16	1.22
SS-RU-TF10-TF6	5/8*	3/8	1.94	0.86	0.76	0.96	0.66	0.28	15/16	1	11/16	1.25
SS-RU-TF10-TF8	5/8*	1/2	2.05	0.86	0.86	0.96	0.90	0.41	15/16	1	7/8	1.25
SS-RU-TF12-TF4	3/4	1/4	1.94	0.86	0.70	0.96	0.60	0.19	1-1/16	1-1/8	9/16	1.25
SS-RU-TF12-TF6	3/4	3/8	2.00	0.86	0.76	0.96	0.66	0.28	1-1/16	1-1/8	11/16	1.31
SS-RU-TF12-TF8	3/4	1/2	2.11	0.86	0.86	0.96	0.90	0.41	1-1/16	1-1/8	7/8	1.31
SS-RU-TF12-TF10	3/4	5/8	2.11	0.86	0.86	0.96	0.96	0.50	1-1/16	1-1/8	1	1.31
SS-RU-TF16-TF8	1	1/2	2.38	1.04	0.86	1.23	0.90	0.41	1-3/8	1-1/2	7/8	1.61
SS-RU-TF16-TF12	1	3/4	2.38	1.04	0.86	1.23	0.96	0.62	1-3/8	1-1/2	1-1/8	1.59

METRIC UNITS

Model Number	T Tube O.D. mm	Tx Tube O.D. mm	A mm	C mm	Cx mm	D mm	Dx mm	E mm	F Hex Flat mm	G Hex Flat mm	Gx mm	H mm
SS-RU-TF6M-TF3M	6	3	38.6	17.7	15.3	15.3	12.9	2.4	14	14	12	24.6
SS-RU-TF8M-TF6M	8	6	42.3	18.6	17.7	16.2	15.3	4.8	15	16	14	27.4
SS-RU-TF10M-TF6M	10	6	44.5	19.5	17.7	17.2	15.3	4.8	18	19	14	29.5
SS-RU-TF10M-TF8M	10	8	45.1	19.5	18.6	17.2	16.2	6.4	18	19	16	30.0
SS-RU-TF12M-TF6M	12	6	47.0	22.0	17.7	22.8	15.3	4.8	22	22	14	29.5
SS-RU-TF12M-TF8M	12	8	47.8	22.0	18.6	22.8	16.2	6.4	22	22	16	30.2
SS-RU-TF12M-TF10M	12	10	48.7	22.0	19.5	22.8	17.2	7.9	22	22	19	31.0

*: Consult factory

TUBE FITTINGS

Union Cross

Solutions for Life

Male Branch Tees

GENLOK to Male NPT Thread Branch

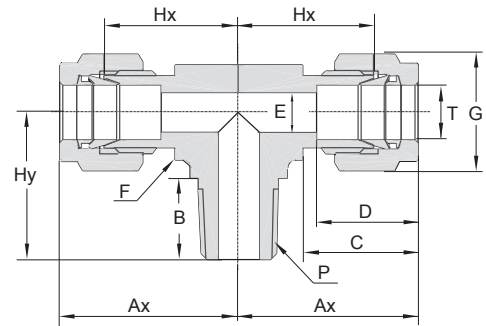
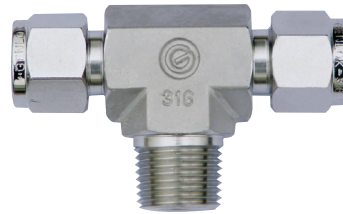

ENGLISH UNITS

Model Number	T Tube O.D. in.	P NPT Male Pipe Size in.	Ax in.	B in.	C in.	D in.	E in.	F Hex Flat in.	G Hex Flat in.	Hx in.	Hy in.
SS-MBT-TF2-NT2	1/8	1/8	0.93	0.38	0.60	0.50	0.09	7/16	7/16	0.67	0.70
SS-MBT-TF2-NT4	1/8	1/4	0.97	0.56	0.60	0.50	0.09	1/2	7/16	0.71	0.92
SS-MBT-TF3-NT2	3/16*	1/8	0.96	0.38	0.63	0.54	0.12	7/16	1/2	0.70	0.70
SS-MBT-TF4-NT2	1/4	1/8	1.06	0.38	0.70	0.60	0.19	1/2	9/16	0.77	0.74
SS-MBT-TF4-NT4	1/4	1/4	1.06	0.56	0.70	0.60	0.19	1/2	9/16	0.77	0.92
SS-MBT-TF5-NT2	5/16*	1/8	1.17	0.38	0.73	0.64	0.19	5/8	5/8	0.88	0.82
SS-MBT-TF6-NT4	3/8	1/4	1.20	0.56	0.76	0.66	0.28	5/8	11/16	0.91	1.00
SS-MBT-TF6-NT6	3/8	3/8	1.31	0.56	0.76	0.66	0.28	13/16	11/16	1.02	1.11
SS-MBT-TF8-NT6	1/2	3/8	1.42	0.56	0.86	0.90	0.38	13/16	7/8	1.02	1.11
SS-MBT-TF8-NT8	1/2	1/2	1.42	0.75	0.86	0.90	0.41	13/16	7/8	1.02	1.30
SS-MBT-TF10-NT8	5/8*	1/2	1.53	0.75	0.86	0.96	0.47	1	1	1.13	1.41
SS-MBT-TF12-NT12	3/4	3/4	1.57	0.75	0.86	0.96	0.62	1-1/16	1-1/8	1.17	1.45

Model Number	T Tube O.D. in.	Tx Tapered Pipe Thread (ISO PT)	Ax in.	B in.	C in.	D in.	E in.	F Hex Flat in.	G Hex Flat in.	Hx in.	Hy in.
SS-MBT-TF2-RT2	1/8	1/8	0.93	0.38	0.60	0.50	0.09	7/16	7/16	0.67	0.70
SS-MBT-TF2-RT4	1/8	1/4	0.97	0.56	0.60	0.50	0.09	1/2	7/16	0.71	0.92
SS-MBT-TF4-RT2	1/4	1/8	1.06	0.38	0.70	0.60	0.19	1/2	9/16	0.77	0.74
SS-MBT-TF4-RT4	1/4	1/4	1.06	0.56	0.70	0.60	0.19	1/2	9/16	0.77	0.92
SS-MBT-TF6-RT4	3/8	1/4	1.20	0.56	0.76	0.66	0.28	5/8	11/16	0.91	1.00
SS-MBT-TF6-RT6	3/8	3/8	1.31	0.56	0.76	0.66	0.28	13/16	11/16	1.02	1.11
SS-MBT-TF8-RT8	1/2	1/2	1.42	0.75	0.86	0.90	0.41	13/16	7/8	1.02	1.30
SS-MBT-TF12-RT12	3/4	3/4	1.57	0.75	0.86	0.96	0.62	1-1/16	1-1/8	1.17	1.45

*: Consult factory

Male Branch Tees

GENLOK to Male NPT Thread Branch

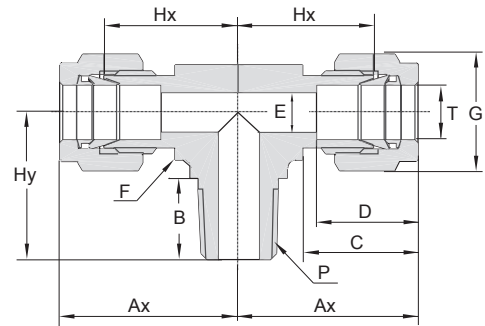
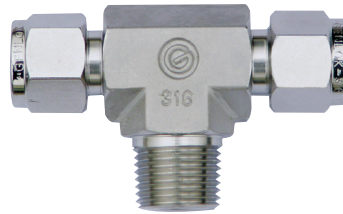

METRIC UNITS

Model Number	T Tube O.D. mm	P NPT Male Pipe Size in.	Ax mm	B mm	C mm	D mm	E mm	F Hex Flat mm	G Hex Flat mm	Hx mm	Hy mm
SS-MBT-TF6M-NT2	6	1/8	27.0	9.70	17.7	15.3	4.8	12.7	14	19.6	18.8
SS-MBT-TF6M-NT4	6	1/4	27.0	14.2	17.7	15.3	4.8	16.0	14	19.6	23.4
SS-MBT-TF8M-NT2	8	1/8	29.9	9.70	18.6	16.2	4.8	16.0	16	22.4	20.8
SS-MBT-TF8M-NT4	8	1/4	29.9	14.2	18.6	16.2	6.4	16.0	16	22.4	25.4
SS-MBT-TF10M-NT4	10	1/4	33.5	14.2	19.5	17.2	7.1	20.5	19	25.9	28.2
SS-MBT-TF12M-NT4	12	1/4	36.0	14.2	22.0	22.8	7.1	20.5	22	25.9	28.2
SS-MBT-TF12M-NT6	12	3/8	36.0	14.2	22.0	22.8	9.5	20.5	22	25.9	28.2
SS-MBT-TF12M-NT8	12	1/2	36.0	19.0	22.0	22.8	9.5	23.8	22	25.9	33.0

Model Number	T Tube O.D. mm	Tx Tapered Pipe Thread (ISO PT)	Ax mm	B mm	C mm	D mm	E mm	F Hex Flat mm	G Hex Flat mm	Hx mm	Hy mm
SS-MBT-TF6M-RT4	6	1/4	27.0	14.2	17.7	15.3	4.8	16.0	14	19.6	23.4
SS-MBT-TF8M-RT4	8	1/4	29.9	14.2	18.6	16.2	6.4	16.0	16	22.4	25.4
SS-MBT-TF12M-RT6	12	3/8	36.0	14.2	22.0	22.8	9.5	20.5	22	25.9	28.2

TUBE FITTINGS

Male Run Tees

Solutions for Life

Male Run Tees

GENLOK to Male NPT Thread Run

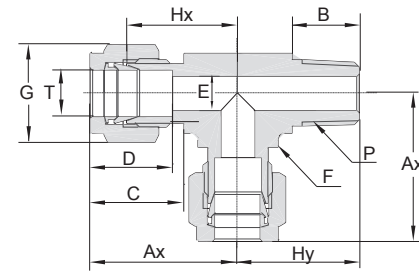
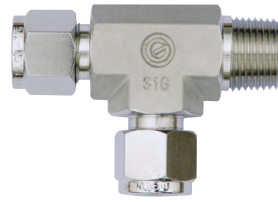

ENGLISH UNITS

Model Number	T Tube O.D. in.	P NPT Male Pipe Size in.	Ax in.	B in.	C in.	D in.	E in.	F Hex Flat in.	G Hex Flat in.	Hx in.	Hy in.
SS-MRT-TF2-NT2	1/8	1/8	0.93	0.38	0.60	0.50	0.09	7/16	7/16	0.67	0.70
SS-MRT-TF2-NT4	1/8	1/4	0.97	0.56	0.60	0.50	0.09	1/2	7/16	0.71	0.92
SS-MRT-TF3-NT2	3/16*	1/8	0.96	0.38	0.63	0.54	0.12	7/16	1/2	0.70	0.70
SS-MRT-TF4-NT2	1/4	1/8	1.06	0.38	0.70	0.60	0.19	1/2	9/16	0.77	0.74
SS-MRT-TF4-NT4	1/4	1/4	1.06	0.56	0.70	0.60	0.19	1/2	9/16	0.77	0.92
SS-MRT-TF5-NT2	5/16*	1/8	1.17	0.38	0.73	0.64	0.19	5/8	5/8	0.88	0.82
SS-MRT-TF6-NT4	3/8	1/4	1.20	0.56	0.76	0.66	0.28	5/8	11/16	0.91	1.00
SS-MRT-TF6-NT6	3/8	3/8	1.31	0.56	0.76	0.66	0.28	5/8	11/16	1.02	1.00
SS-MRT-TF8-NT6	1/2	3/8	1.42	0.56	0.86	0.90	0.38	13/16	7/8	1.02	1.11
SS-MRT-TF8-NT8	1/2	1/2	1.42	0.75	0.86	0.90	0.41	13/16	7/8	1.02	1.30
SS-MRT-TF10-NT8	5/8*	1/2	1.50	0.75	0.86	0.96	0.47	15/16	1	1.10	1.38
SS-MRT-TF12-NT12	3/4	3/4	1.57	0.75	0.86	0.96	0.62	1-1/16	1-1/8	1.17	1.45

Model Number	T Tube O.D. in.	P Tapered Pipe Thread (ISO PT)	Ax in.	B in.	C in.	D in.	E in.	F Hex Flat in.	G Hex Flat in.	Hx in.	Hy in.
SS-MRT-TF2-RT2	1/8	1/8	0.93	0.38	0.60	0.50	0.09	7/16	7/16	0.67	0.70
SS-MRT-TF2-RT4	1/8	1/4	0.97	0.56	0.60	0.50	0.09	1/2	7/16	0.71	0.92
SS-MRT-TF4-RT2	1/4	1/8	1.06	0.38	0.70	0.60	0.19	1/2	9/16	0.77	0.74
SS-MRT-TF4-RT4	1/4	1/4	1.06	0.56	0.70	0.60	0.19	1/2	9/16	0.77	0.92
SS-MRT-TF6-RT4	3/8	1/4	1.20	0.56	0.76	0.66	0.28	5/8	11/16	0.91	1.00
SS-MRT-TF6-RT6	3/8	3/8	1.31	0.56	0.76	0.66	0.28	5/8	11/16	1.02	1.00
SS-MRT-TF8-RT8	1/2	1/2	1.42	0.75	0.86	0.90	0.41	13/16	7/8	1.02	1.30
SS-MRT-TF12-RT12	3/4	3/4	1.57	0.75	0.86	0.96	0.62	1-1/16	1-1/8	1.17	1.45

METRIC UNITS

Model Number	T Tube O.D. mm	P NPT Male Pipe Size in.	Ax mm	B mm	C mm	D mm	E mm	F Hex Flat mm	G Hex Flat mm	Hx mm	Hy mm
SS-MRT-TF6M-NT2	6	1/8	27.0	9.70	17.7	15.3	4.8	12.7	14	19.6	18.8
SS-MRT-TF6M-NT4	6	1/4	27.0	14.2	17.7	15.3	4.8	16.0	14	19.6	23.4
SS-MRT-TF8M-NT2	8	1/8	29.9	9.70	18.6	16.2	4.8	16.0	16	22.4	20.8
SS-MRT-TF8M-NT4	8	1/4	29.9	14.2	18.6	16.2	6.4	16.0	16	22.4	25.4
SS-MRT-TF10M-NT4	10	1/4	33.5	14.2	19.5	17.2	7.1	20.5	19	25.9	28.2
SS-MRT-TF12M-NT4	12	1/4	36.0	14.2	22.0	22.8	7.1	20.5	22	25.9	28.2
SS-MRT-TF12M-NT6	12	3/8	36.0	14.2	22.0	22.8	9.5	20.5	22	25.9	28.2
SS-MRT-TF12M-NT8	12	1/2	36.0	19.0	22.0	22.8	9.5	23.8	22	25.9	33.0

Model Number	T Tube O.D. mm	P Tapered Pipe Thread (ISO PT)	Ax mm	B mm	C mm	D mm	E mm	F Hex Flat mm	G Hex Flat mm	Hx mm	Hy mm
SS-MRT-TF6M-RT4	6	1/4	27.0	14.2	17.7	15.3	4.8	16.0	14	19.6	23.4
SS-MRT-TF8M-RT4	8	1/4	29.9	14.2	18.6	16.2	6.4	16.0	16	22.4	25.4
SS-MRT-TF12M-RT6	12	3/8	36.0	14.2	22.0	22.8	9.5	20.5	22	25.9	28.2

*: Consult factory

Female Branch Tees

GENLOK to Female NPT Thread Branch

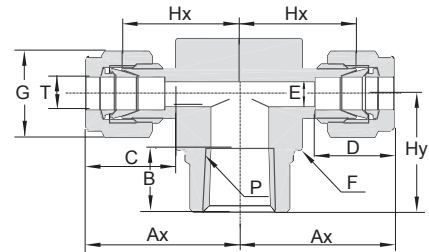

ENGLISH UNITS

Model Number	T Tube O.D. in.	P NPT Male Pipe Size in.	Ax in.	B in.	C in.	D in.	E in.	F Hex Flat in.	G Hex Flat in.	Hx in.	Hy in.
SS-FBT-TF2-FNT2	1/8	1/8	0.97	0.41	0.60	0.50	0.09	5/8	7/16	0.71	0.75
SS-FBT-TF4-FNT2	1/4	1/8	1.06	0.41	0.70	0.60	0.19	5/8	9/16	0.77	0.75
SS-FBT-TF4-FNT4	1/4	1/4	1.17	0.59	0.70	0.60	0.19	13/16	9/16	0.88	0.88
SS-FBT-TF6-FNT4	3/8	1/4	1.23	0.59	0.76	0.66	0.28	13/16	11/16	0.94	0.88
SS-FBT-TF6-FNT6	3/8	3/8	1.31	0.59	0.76	0.66	0.28	15/16	11/16	1.02	0.88
SS-FBT-TF6-FNT8	3/8	1/2	1.42	0.78	0.76	0.66	0.28	1-1/16	11/16	1.13	1.12
SS-FBT-TF8-FNT4	1/2	1/4	1.42	0.59	0.86	0.90	0.41	13/16	7/8	1.02	0.88
SS-FBT-TF8-FNT6	1/2	3/8	1.42	0.59	0.86	0.90	0.41	15/16	7/8	1.02	0.88
SS-FBT-TF8-FNT8	1/2	1/2	1.53	0.78	0.86	0.90	0.41	15/16	7/8	1.13	1.12
SS-FBT-TF10-FNT8	5/8*	1/2	1.53	0.78	0.86	0.96	0.50	1-1/8	1	1.13	1.12
SS-FBT-TF12-FNT12	3/4	3/4	1.76	0.81	0.86	0.96	0.62	1-3/8	1-1/8	1.36	1.25
SS-FBT-TF16-FNT12	1	3/4	1.93	0.81	1.04	1.23	0.88	1-3/8	1-1/2	1.45	1.25
SS-FBT-TF16-FNT16	1	1	2.11	1.00	1.04	1.23	0.88	1-11/16	1-1/2	1.63	1.50

Model Number	T Tube O.D. in.	P Tapered Pipe Thread (ISO PT)	Ax in.	B in.	C in.	D in.	E in.	F Hex Flat in.	G Hex Flat in.	Hx in.	Hy in.
SS-FBT-TF2-FRT2	1/8	1/8	0.97	0.41	0.60	0.50	0.09	5/8	7/16	0.71	0.75
SS-FBT-TF4-FRT2	1/4	1/8	1.06	0.41	0.70	0.60	0.19	5/8	9/16	0.77	0.75
SS-FBT-TF4-FRT4	1/4	1/4	1.17	0.59	0.70	0.60	0.19	13/16	9/16	0.88	0.88
SS-FBT-TF6-FRT4	3/8	1/4	1.23	0.59	0.76	0.66	0.28	13/16	11/16	0.94	0.88
SS-FBT-TF6-FRT6	3/8	3/8	1.31	0.59	0.76	0.66	0.28	15/16	11/16	1.02	0.88
SS-FBT-TF8-FRT6	1/2	3/8	1.42	0.59	0.86	0.90	0.41	15/16	7/8	1.02	0.88
SS-FBT-TF8-FRT8	1/2	1/2	1.53	0.78	0.86	0.90	0.41	15/16	7/8	1.13	1.12

METRIC UNITS

Model Number	T Tube O.D. mm	P NPT Male Pipe Size in.	Ax mm	B mm	C mm	D mm	E mm	F Hex Flat mm	G Hex Flat mm	Hx mm	Hy mm
SS-FRT-TF6M-FNT2	6	1/8	27.0	10.4	17.7	15.3	4.8	16.0	14	19.6	19.0
SS-FRT-TF6M-FNT4	6	1/4	29.8	15.0	17.7	15.3	4.8	20.5	14	22.4	22.4
SS-FRT-TF8M-FNT2	8	1/8	29.9	10.4	18.6	16.2	6.4	16.0	16	22.4	19.0
SS-FRT-TF8M-FNT4	8	1/4	30.6	15.0	18.6	16.2	6.4	20.5	16	23.1	22.4
SS-FRT-TF10M-FNT4	10	1/4	33.5	15.0	19.5	17.2	7.9	20.5	19	25.9	22.4
SS-FRT-TF12M-FNT4	12	1/4	36.0	15.0	22.0	22.8	9.5	20.5	22	25.9	22.4
SS-FRT-TF12M-FNT6	12	3/8	36.0	15.0	22.0	22.8	10.3	23.8	22	25.9	22.4

Model Number	T Tube O.D. mm	P Tapered Pipe Thread (ISO PT)	Ax mm	B mm	C mm	D mm	E mm	F Hex Flat mm	G Hex Flat mm	Hx mm	Hy mm
SS-FBT-TF6M-FRT4	6	1/4	29.8	15.0	17.7	15.3	4.8	20.5	14	22.4	22.4
SS-FBT-TF8M-FRT4	8	1/4	30.6	15.0	18.6	16.2	6.4	20.5	16	23.1	22.4
SS-FBT-TF12M-FRT6	12	3/8	36.0	15.0	22.0	22.8	9.5	23.8	22	25.9	22.4

*: Consult factory

TUBE FITTINGS

Female Run Tees

Solutions for Life

Female Run Tees

GENLOK to Female NPT Thread Run

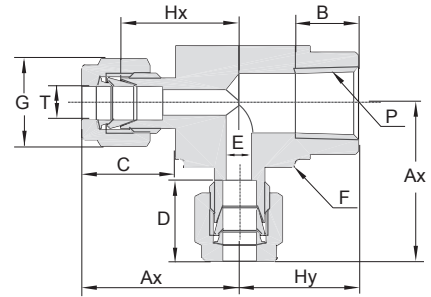
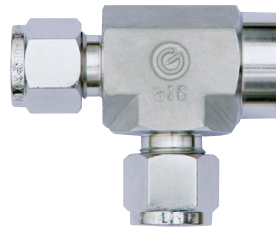

ENGLISH UNITS

Model Number	T Tube O.D. in.	P NPT Male Pipe Size in.	Ax in.	B in.	C in.	D in.	E in.	F Hex Flat in.	G Hex Flat in.	Hx in.	Hy in.
SS-FRT-TF2-FRT2	1/8	1/8	0.97	0.41	0.60	0.50	0.09	5/8	7/16	0.71	0.75
SS-FRT-TF4-FRT2	1/4	1/8	1.06	0.41	0.70	0.60	0.19	5/8	9/16	0.77	0.75
SS-FRT-TF4-FRT4	1/4	1/4	1.17	0.59	0.70	0.60	0.19	13/16	9/16	0.88	0.88
SS-FRT-TF6-FRT4	3/8	1/4	1.23	0.59	0.76	0.66	0.28	13/16	11/16	0.94	0.88
SS-FRT-TF8-FRT6	1/2	3/8	1.42	0.59	0.86	0.90	0.41	15/16	7/8	1.02	0.88
SS-FRT-TF8-FRT8	1/2	1/2	1.57	0.78	0.86	0.90	0.41	1-1/8	7/8	1.17	1.12

Model Number	T Tube O.D. in.	P Tapered Pipe Thread (ISO PT)	Ax in.	B in.	C in.	D in.	E in.	F Hex Flat in.	G Hex Flat in.	Hx in.	Hy in.
SS-FRT-TF2-FRT2	1/8	1/8	0.97	0.41	0.60	0.50	0.09	5/8	7/16	0.71	0.75
SS-FRT-TF4-FRT2	1/4	1/8	1.06	0.41	0.70	0.60	0.19	5/8	9/16	0.77	0.75
SS-FRT-TF4-FRT4	1/4	1/4	1.17	0.59	0.70	0.60	0.19	13/16	9/16	0.88	0.88
SS-FRT-TF6-FRT4	3/8	1/4	1.23	0.59	0.76	0.66	0.28	13/16	11/16	0.94	0.88
SS-FRT-TF8-FRT6	1/2	3/8	1.42	0.59	0.86	0.90	0.41	15/16	7/8	1.02	0.88
SS-FRT-TF8-FRT8	1/2	1/2	1.57	0.78	0.86	0.90	0.41	1-1/8	7/8	1.17	1.12

METRIC UNITS

Model Number	T Tube O.D. mm	P NPT Male Pipe Size in.	Ax mm	B mm	C mm	D mm	E mm	F Hex Flat mm	G Hex Flat mm	Hx mm	Hy mm
SS-FRT-TF6M-FNT2	6	1/8	27.0	10.4	17.7	15.3	4.8	16.0	14	19.6	19.0
SS-FRT-TF6M-FNT4	6	1/4	29.8	15.0	17.7	15.3	4.8	20.5	14	22.4	22.4
SS-FRT-TF8M-FNT2	8	1/8	29.9	10.4	18.6	16.2	6.4	16.0	16	22.4	19.0
SS-FRT-TF8M-FNT4	8	1/4	30.6	15.0	18.6	16.2	6.4	20.5	16	23.1	22.4
SS-FRT-TF10M-FNT4	10	1/4	33.5	15.0	19.5	17.2	7.9	20.5	19	25.9	22.4
SS-FRT-TF12M-FNT4	12	1/4	36.0	15.0	22.0	22.8	9.5	20.5	22	25.9	22.4
SS-FRT-TF12M-FNT6	12	3/8	36.0	15.0	22.0	22.8	10.3	23.8	22	25.9	22.4

Model Number	T Tube O.D. mm	P Tapered Pipe Thread (ISO PT)	Ax mm	B mm	C mm	D mm	E mm	F Hex Flat mm	G Hex Flat mm	Hx mm	Hy mm
SS-FRT-TF6M-FRT4	6	1/4	29.8	15.0	17.7	15.3	4.8	20.5	14	22.4	22.4
SS-FRT-TF8M-FRT4	8	1/4	30.6	15.0	18.6	16.2	6.4	20.5	16	23.1	22.4
SS-FRT-TF12M-FRT6	12	3/8	36.0	15.0	22.0	22.8	10.3	23.8	22	25.9	22.4

Reducing Union Tees

Reducing Union Tees

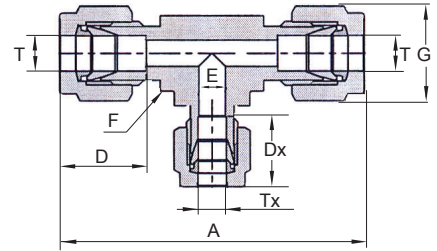
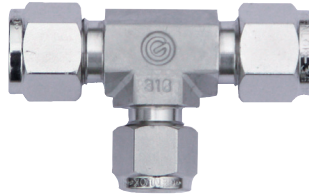

ENGLISH UNITS

Model Number	T Tube O.D. in.	Tx Tube O.D. in.	A in.	Ax in.	D in.	Dx in.	E in.	F Hex Flat in.
SS-RUT-TF6-TF4	3/8	1/4	2.40	1.14	0.66	0.60	0.19	5/8
SS-RUT-TF8-TF4	1/2	1/4	2.84	1.25	0.90	0.60	0.19	13/16
SS-RUT-TF8-TF6	1/2	3/8	2.84	1.31	0.90	0.66	0.28	13/16
SS-RUT-TF10-TF6	5/8*	3/8	3.06	1.42	0.96	0.66	0.28	15/16
SS-RUT-TF12-TF6	3/4	3/8	3.14	1.46	0.96	0.66	0.28	1-1/8
SS-RUT-TF12-TF8	3/4	1/2	3.14	1.57	0.96	0.90	0.41	1-1/8
SS-RUT-TF16-TF6	1	3/8	3.86	1.65	1.23	0.66	0.28	1-3/8
SS-RUT-TF16-TF8	1	1/2	3.86	1.76	1.23	0.90	0.41	1-3/8
SS-RUT-TF16-TF12	1	3/4	3.86	1.76	1.23	0.96	0.62	1-3/8

*: Consult factory

Plugs

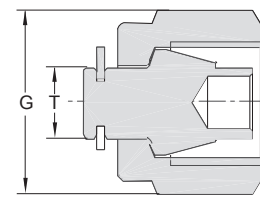
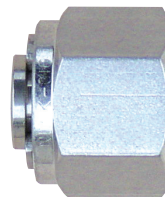

ENGLISH UNITS

Model Number	T Tube O.D. in.	G Hex Flat in.
SS-P-TF2	1/8	7/16
SS-P-TF3	3/16*	1/2
SS-P-TF4	1/4	9/16
SS-P-TF5	5/16*	5/8
SS-P-TF6	3/8	11/16
SS-P-TF8	1/2	7/8
SS-P-TF10	5/8*	1
SS-P-TF12	3/4	1-1/8
SS-P-TF16	1	1-1/2

METRIC UNITS

Model Number	T Tube O.D. mm	G Hex Flat mm
SS-P-TF3M	3	12
SS-P-TF6M	6	14
SS-P-TF8M	8	16
SS-P-TF10M	10	19
SS-P-TF12M	12	22

*: Consult factory

TUBE FITTINGS

Caps

Solutions for Life

Caps

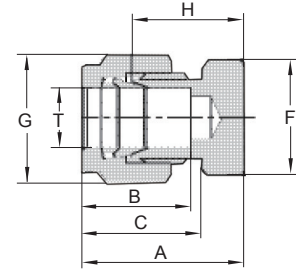

ENGLISH UNITS

Model Number	T Tube O.D. in.	A in.	C in.	D in.	F Hex Flat in.	G Hex Flat in.	H in.
SS-C-TF2	1/8	0.79	0.60	0.50	7/16	7/16	0.53
SS-C-TF3	3/16*	0.84	0.63	0.54	7/16	1/2	0.58
SS-C-TF4	1/4	0.92	0.70	0.60	1/2	9/16	0.62
SS-C-TF5	5/16*	0.96	0.73	0.64	9/16	5/8	0.67
SS-C-TF6	3/8	1.01	0.76	0.66	5/8	11/16	0.72
SS-C-TF8	1/2	1.15	0.86	0.90	13/16	7/8	0.75
SS-C-TF10	5/8*	1.18	0.86	0.96	15/16	1	0.78
SS-C-TF12	3/4	1.24	0.86	0.96	1-1/16	1-1/8	0.84
SS-C-TF16	1	1.51	1.04	1.23	1-3/8	1-1/2	1.03

METRIC UNITS

Model Number	T Tube O.D. mm	A mm	C mm	D mm	F Hex Flat mm	G Hex Flat mm	H mm
SS-C-TF3M	3	20.1	15.3	12.9	12	12	13.5
SS-C-TF6M	6	23.1	17.7	15.3	14	14	15.7
SS-C-TF8M	8	24.5	18.6	16.2	15	16	17.0
SS-C-TF10M	10	26.6	19.5	17.2	18	19	19.0
SS-C-TF12M	12	29.1	22.0	22.8	22	22	19.0

*: Consult factory

Nuts

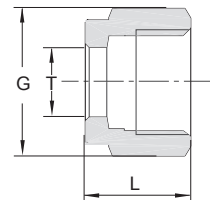
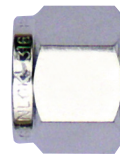

ENGLISH UNITS

Model Number	T Tube O.D. in.	G Hex Flat in.	L in.
SS-N-TF2	1/8	7/16	0.47
SS-N-TF3	3/16*	1/2	0.47
SS-N-TF4	1/4	9/16	0.50
SS-N-TF5	5/16*	5/8	0.53
SS-N-TF6	3/8	11/16	0.56
SS-N-TF8	1/2	7/8	0.69
SS-N-TF10	5/8*	1	0.69
SS-N-TF12	3/4	1-1/8	0.69
SS-N-TF16	1	1-1/2	0.81

METRIC UNITS

Model Number	T Tube O.D. mm	G Hex Flat mm	L mm
SS-N-TF3M	3	12	11.9
SS-N-TF6M	6	14	12.7
SS-N-TF8M	8	16	13.5
SS-N-TF10M	10	19	15.1
SS-N-TF12M	12	22	17.4

*: Consult factory

Back Ferrules

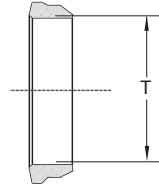

ENGLISH UNITS

Model Number	T Tube O.D. in.
SS-BF-TF2	1/8
SS-BF-TF3	3/16*
SS-BF-TF4	1/4
SS-BF-TF5	5/16*
SS-BF-TF6	3/8
SS-BF-TF8	1/2
SS-BF-TF10	5/8*
SS-BF-TF12	3/4
SS-BF-TF16	1

METRIC UNITS

Model Number	T Tube O.D. mm
SS-BF-TF3M	3
SS-BF-TF6M	6
SS-BF-TF8M	8
SS-BF-TF10M	10
SS-BF-TF12M	12

Front Ferrules

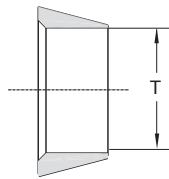

ENGLISH UNITS

Model Number	T Tube O.D. in.
SS-FF-TF2	1/8
SS-FF-TF3	3/16*
SS-FF-TF4	1/4
SS-FF-TF5	5/16*
SS-FF-TF6	3/8
SS-FF-TF8	1/2
SS-FF-TF10	5/8*
SS-FF-TF12	3/4
SS-FF-TF16	1

METRIC UNITS

Model Number	T Tube O.D. mm
SS-FF-TF3M	3
SS-FF-TF6M	6
SS-FF-TF8M	8
SS-FF-TF10M	10
SS-FF-TF12M	12

Ferrules Set

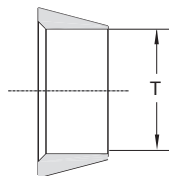
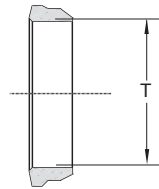

ENGLISH UNITS

Model Number	T Tube O.D. in.
SS-FSET-TF2	1/8
SS-FSET-TF3	3/16*
SS-FSET-TF4	1/4
SS-FSET-TF5	5/16*
SS-FSET-TF6	3/8
SS-FSET-TF8	1/2
SS-FSET-TF10	5/8*
SS-FSET-TF12	3/4
SS-FSET-TF16	1

METRIC UNITS

Model Number	T Tube O.D. mm
SS-FSET-TF3M	3
SS-FSET-TF6M	6
SS-FSET-TF8M	8
SS-FSET-TF10M	10
SS-FSET-TF12M	12

*: Consult factory



Gas Control Systems Solutions Overview

- Manifold Systems
- Control Panels
- HP/UHP Regulators
- Pressure Gauges
- Valves & Fittings



Specialty Manifold Systems

- Chrome-plated Brass Specialty Gas Control Panels
- Stainless Steel Specialty Gas Control Panels
- Specialty Gas Manifolds
- Terminal Gas Control Panel
- Other Control Systems
- Accessories



Specialty Gas Regulators & Gauges

- General Purpose Forged Brass Regulators
- High Purity Brass Barstock Regulators
- High Purity Stainless Steel Barstock Regulators
- Accessories



Valves

- Needle Valves
- Ball Valves
- Diaphragm Valves
- Cylinder Valves
- Metering Valves
- Gauge Valves
- Check Valves



Ultra High Purity

- UHP Regulators
- UHP Diaphragm valves
- UHP Gauges
- UHP Fittings
- Vacuum Generators



Cryogenic Gas Equipment

- Cryogenic Relief Valves
- Cryogenic Shut-Off Valves
- Regulators
- Check Valves & Burst-Disc
- LNG Nozzle/Quick Disconnect, Receptacle
- Excess Flow Valves
- Pressure Gauges

Please contact us for any questions about catalogs.

- Requesting Catalogs
- Register an account to view / download pdf catalogs. (Online Register)

To view our full line of Specialty Gas Products please visit us online at www.gentec.com



GENSTAR TECHNOLOGIES COMPANY INC.

4525 Edison Ave, Chino, CA 91710

Tel: 909.606.6726

Fax: 909.606.6485

www.gentec.com

